



TOIK





TOIK is the wall luminaire with **soft and minimal lines**. The perfect solution to illuminate passageways and common spaces, enriching them with the decorative and elegant design of the aluminum body. Available in **different lengths and colors**, in the indirect light version and in the direct / indirect bi-emission version, it provides the possibility of integrating daylight sensor, emergency light module and connections for home automation systems. **TOIK** is characterized by its **great technological content** in an essential and compact body, for a **high quality of light and versatility** of use.

ID 56









esse-ci

FEATURES

-  Direct/Indirect emission
-  Emissione Indiretta
-  UGR < 22
-  IP 40





LED

-  3000K/4000K
-  >100lm/W
-  CRI >90
-  Eye safety: R60
-  Mac Adams 3
-  L80/B10 >50.000h

CERTIFICATIONS

-  EEA Conformity
-  Energy efficiency
-  5 years warranty

ON REQUEST

-  DALI - code D
-  Bluetooth - code BT*
-  Built-in PIR/Daylight sensor - code S*
-  Emergency 1 hr - code EM
Emergency 3 hrs - code EM3H*
-  2700K - code K27*

SPECIFICATIONS

Built-in driver.
Antistatic satin methacrylate diffuser for homogeneous emission with UGR <22.

BODY

Aluminum with epoxy powder coating.

COLORS

White RAL 9003 wrinkled - code W
Black RAL 9005 wrinkled - code BK

* Where available

TOIK

IP 40

Antistatic satin methacrylate diffuser
UGR <22 with indirect emission.

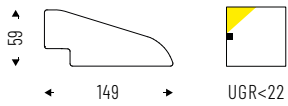

Cod. 4000K	☼	lm	mm
56IN22K4	22W	2389	401
56IN44K4	44W	4770	706
56IN66K4	66W	7150	1011

Cod. 3000K	☼	lm	mm
56IN22K3	22W	2250	401
56IN44K3	44W	4500	706
56IN66K3	66W	6740	1011

TOIK DOUBLE EMISSION

IP 40

Antistatic satin methacrylate diffuser
UGR <22 with direct/indirect emission.

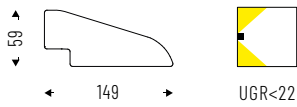

Cod. 4000K	☼	lm	mm
56DI28K4	28W	2771	401
56DI56K4	56W	5540	706
56DI84K4	84W	8305	1011

Cod. 3000K	☼	lm	mm
56DI28K3	28W	2650	401
56DI56K3	56W	5300	706
56DI84K3	84W	7940	1011

TECHNICAL NOTES



AVAILABLE CONFIGURATIONS

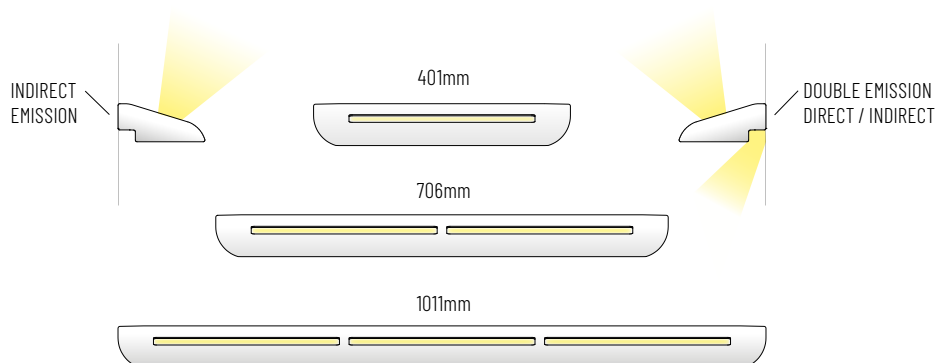

WALL/FLOOR