



TERES

Design ESSE-CI



η >95 lm/W; >130 lm/W

CRI >80; >90

IP 40

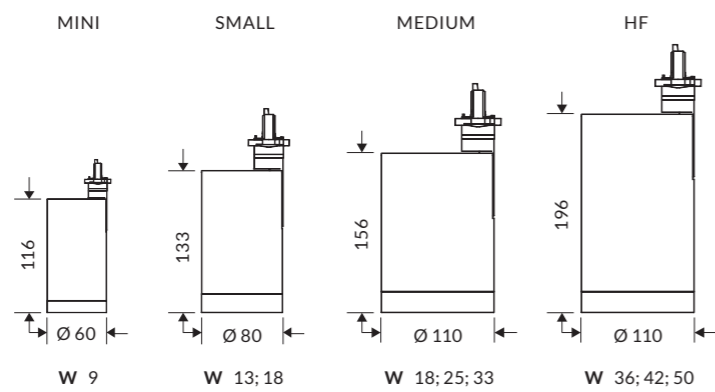



TERES

Movement and vitality are the formal aspects that characterize teres, the most sophisticated and professional spotlight on track. Thanks to the built-in driver, the slim design and the most advanced technology, it's able to completely integrate with the environment without being invasive.

The powers, reflectors, lens and optics, make this range extremely functional and suitable for every context.

TERES becomes even more efficient with the new "High Flux" version designed for areas where an high level of lighting performance is required.

Installable on Eurostandard track.

SPECIFICATIONS

- Integrated driver
- Colour temperature: 3000K/4000K
- CRI>80; CRI>90
- McAdams 3
- Life Time: L80/B50 >50.000h
- 5 years complete warranty
- Eye safety: risk-free (RG 0) in accordance with EN62471:2009

OPTICS

- VT reflectors from 10° - 15° -20° - 36° -40° - 50° - 70° beam angles
- PC polycarbonate lens from 12° - 24° beam angles
- ZOOM internal reflectors with adjustable emission from 25 ° to 60 °
- Mat glass
- Sculpture optic
- Honeycomb optic

BODY

Manufactured from pressure die-cast aluminum with epoxy powder coating.

LEGAL REFERENCES

In compliance with the safety standards EN 60 598-1 and UNI EN 12464-1 (lighting for working places).

CERTIFICATIONS

CE IP20 IP40

ErP Class: A+



COLOURS

- White RAL 9003 wrinkled - Code: W
- Black RAL 9005 wrinkled - Code: BK

ON REQUEST

- Colour temperature 2700K/5000K
- Wiring DALI dimmable - Code: RDD (verify the version available)
- Driver Bluetooth - Code: BT (available for MEDIUM version)

VERSIONS

- | | |
|-------------------------|---------------------------|
| TERES VT MINI | TERES PC SMALL PREMIUM |
| TERES VT MINI PREMIUM | TERES PC MEDIUM |
| TERES VT SMALL | TERES PC MEDIUM PREMIUM |
| TERES VT SMALL PREMIUM | TERES ZOOM SMALL PREMIUM |
| TERES VT MEDIUM | TERES ZOOM MEDIUM PREMIUM |
| TERES VT MEDIUM PREMIUM | TERES HF VT PREMIUM |
| TERES PC MINI | TERES MEDIUM FOOD |
| TERES PC MINI PREMIUM | ACCESSORIES |
| TERES PC SMALL | |



TERES VT MINI



OPTIC

Internal aluminum reflectors:
15° - 20° - 36° - 50° beam angles.

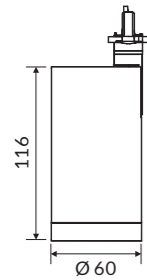

IP 20 A*

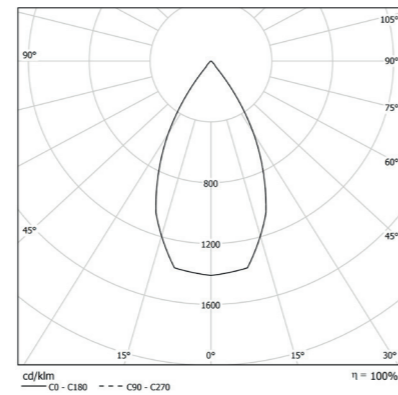

COLOUR TEMPERATURE //

4 0 0 0 K

COD	Light Bulb Icon	lm
14VT9L415	9W 15° 4000K	1152
14VT9L420	9W 20° 4000K	1152
14VT9L436	9W 36° 4000K	1152
14VT9L450	9W 50° 4000K	1152

3 0 0 0 K

COD	Light Bulb Icon	lm
14VT9L315	9W 15° 3000K	972
14VT9L320	9W 20° 3000K	972
14VT9L336	9W 36° 3000K	972
14VT9L350	9W 50° 3000K	972



TERES

TERES VT MINI Premium CRI > 90



OPTIC

Internal aluminum reflectors:
15° - 20° - 36° - 50° beam angles.

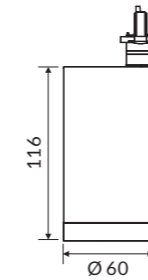

IP 20 A*

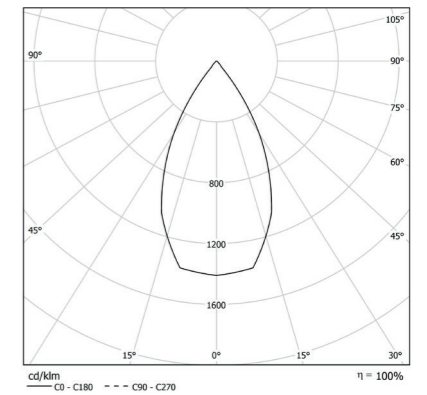

COLOUR TEMPERATURE //

4 0 0 0 K

COD	Light Bulb Icon	lm
14VT9L41590	9W 15° 4000K	1094
14VT9L42090	9W 20° 4000K	1094
14VT9L43690	9W 36° 4000K	1094
14VT9L45090	9W 50° 4000K	1094

3 0 0 0 K

COD	Light Bulb Icon	lm
14VT9L31590	9W 15° 3000K	923
14VT9L32090	9W 20° 3000K	923
14VT9L33690	9W 36° 3000K	923
14VT9L35090	9W 50° 3000K	923



TERES VT SMALL



OPTIC

Internal aluminum reflectors:
10°- 20°- 40° - 50° beam angles.

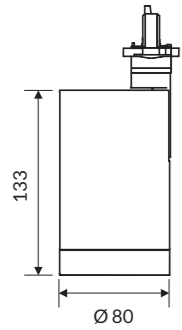

IP 20 A+

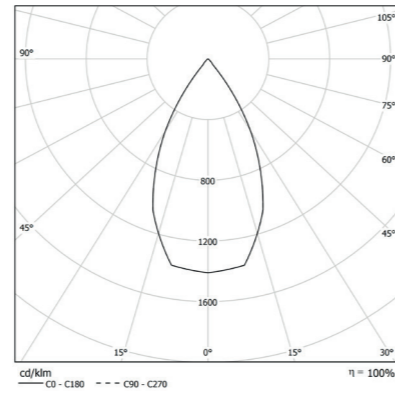

COLOUR TEMPERATURE //

4000 K

COD	💡	lm
14VT13L410S	13W 10° 4000K	1239
14VT13L420S	13W 20° 4000K	1239
14VT13L440S	13W 40° 4000K	1239
14VT13L450S	13W 50° 4000K	1239
14VT18L410S	18W 10° 4000K	1715
14VT18L420S	18W 20° 4000K	1715
14VT18L440S	18W 40° 4000K	1715
14VT18L450S	18W 50° 4000K	1715

3000 K

COD	💡	lm
14VT13L310S	13W 10° 3000K	1187
14VT13L320S	13W 20° 3000K	1187
14VT13L340S	13W 40° 3000K	1187
14VT13L350S	13W 50° 3000K	1187
14VT18L310S	18W 10° 3000K	1644
14VT18L320S	18W 20° 3000K	1644
14VT18L340S	18W 40° 3000K	1644
14VT18L350S	18W 50° 3000K	1644



TERES

TERES VT SMALL Premium CRI > 90



OPTIC

Internal aluminum reflectors:
10°- 20°- 40° - 50° beam angles.

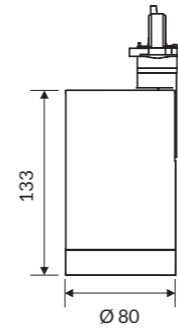

IP 20 A+

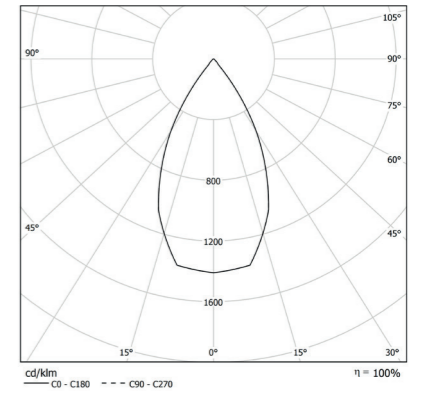

COLOUR TEMPERATURE //

4000 K

COD	💡	lm
14VT13L410S90	13W 10° 4000K	1072
14VT13L420S90	13W 20° 4000K	1072
14VT13L440S90	13W 40° 4000K	1072
14VT13L450S90	13W 50° 4000K	1072
14VT18L410S90	18W 10° 4000K	1485
14VT18L420S90	18W 20° 4000K	1485
14VT18L440S90	18W 40° 4000K	1485
14VT18L450S90	18W 50° 4000K	1485

3000 K

COD	💡	lm
14VT13L310S90	13W 10° 3000K	1020
14VT13L320S90	13W 20° 3000K	1020
14VT13L340S90	13W 40° 3000K	1020
14VT13L350S90	13W 50° 3000K	1020
14VT18L310S90	18W 10° 3000K	1413
14VT18L320S90	18W 20° 3000K	1413
14VT18L340S90	18W 40° 3000K	1413
14VT18L350S90	18W 50° 3000K	1413



TERES VT MEDIUM



OPTIC

Internal aluminum reflectors:
10°- 20°- 40° - 70° beam angles.

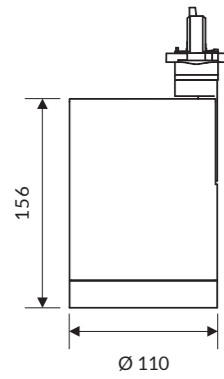

IP 20 A*

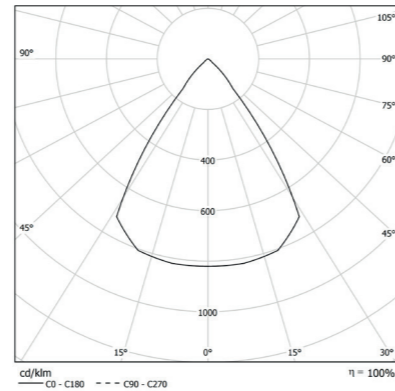

COLOUR TEMPERATURE //

4000 K

COD	💡	lm
14VT18L410M	18W 10° 4000K	2490
14VT18L420M	18W 20° 4000K	2490
14VT18L440M	18W 40° 4000K	2490
14VT18L470M	18W 70° 4000K	2490
14VT25L410M	25W 10° 4000K	3388
14VT25L420M	25W 20° 4000K	3388
14VT25L440M	25W 40° 4000K	3388
14VT25L470M	25W 70° 4000K	3388
14VT33L410M	33W 10° 4000K	4472
14VT33L420M	33W 20° 4000K	4472
14VT33L440M	33W 40° 4000K	4472
14VT33L470M	33W 70° 4000K	4472

3000 K

COD	💡	lm
14VT18L310M	18W 10° 3000K	2409
14VT18L320M	18W 20° 3000K	2409
14VT18L340M	18W 40° 3000K	2409
14VT18L370M	18W 70° 3000K	2409
14VT25L310M	25W 10° 3000K	3277
14VT25L320M	25W 20° 3000K	3277
14VT25L340M	25W 40° 3000K	3277
14VT25L370M	25W 70° 3000K	3277
14VT33L310M	33W 10° 3000K	4326
14VT33L320M	33W 20° 3000K	4326
14VT33L340M	33W 40° 3000K	4326
14VT33L370M	33W 70° 3000K	4326



TERES



TERES VT MEDIUM Premium CRI > 90

OPTIC

Internal aluminum reflectors:
10°- 20°- 40° - 70° beam angles.

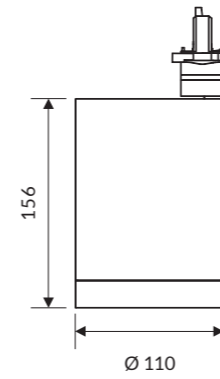

IP 20 A*

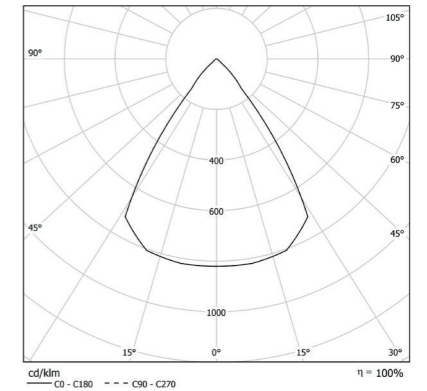

COLOUR TEMPERATURE //

4000 K

COD	💡	lm
14VT18L410M90	18W 10° 4000K	2051
14VT18L420M90	18W 20° 4000K	2051
14VT18L440M90	18W 40° 4000K	2051
14VT18L470M90	18W 70° 4000K	2051
14VT25L410M90	25W 10° 4000K	2790
14VT25L420M90	25W 20° 4000K	2790
14VT25L440M90	25W 40° 4000K	2790
14VT25L470M90	25W 70° 4000K	2790
14VT33L410M90	33W 10° 4000K	3683
14VT33L420M90	33W 20° 4000K	3683
14VT33L440M90	33W 40° 4000K	3683
14VT33L470M90	33W 70° 4000K	3683

3000 K

COD	💡	lm
14VT18L310M90	18W 10° 3000K	1985
14VT18L320M90	18W 20° 3000K	1985
14VT18L340M90	18W 40° 3000K	1985
14VT18L370M90	18W 70° 3000K	1985
14VT25L310M90	25W 10° 3000K	2701
14VT25L320M90	25W 20° 3000K	2701
14VT25L340M90	25W 40° 3000K	2701
14VT25L370M90	25W 70° 3000K	2701
14VT33L310M90	33W 10° 3000K	3566
14VT33L320M90	33W 20° 3000K	3566
14VT33L340M90	33W 40° 3000K	3566
14VT33L370M90	33W 70° 3000K	3566



TERES PC MINI



OPTIC

Polycarbonate lens: 12°- 24° beam angles.

IP 40 A+

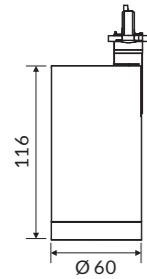
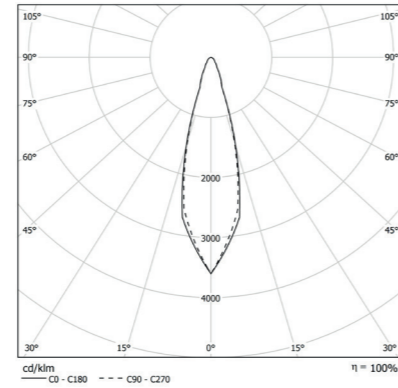

COLOUR TEMPERATURE //

4 0 0 0 K

COD		lm
14PC9L412	9W 12° 4000K	1152
14PC9L424	9W 24° 4000K	1152

3 0 0 0 K

COD		lm
14PC9L312	9W 12° 3000K	972
14PC9L324	9W 24° 3000K	972



TERES PC MINI Premium CRI > 90



TERES

OPTIC

Polycarbonate lens: 12°- 24° beam angles.

IP 40 A+

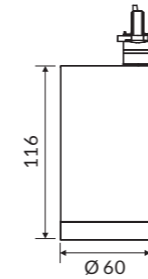
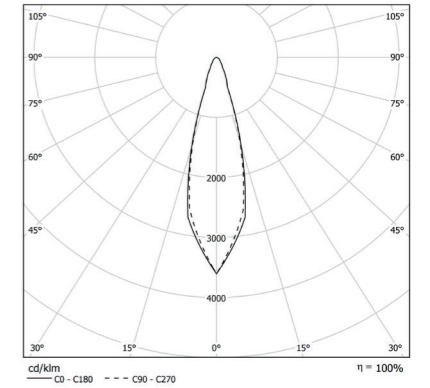

COLOUR TEMPERATURE //

4 0 0 0 K

COD		lm
14PC9L41290	9W 12° 4000K	1094
14PC9L42490	9W 24° 4000K	1094

3 0 0 0 K

COD		lm
14PC9L31290	9W 12° 3000K	923
14PC9L32490	9W 24° 3000K	923



TERES PC SMALL



OPTIC

Polycarbonate lens: 12°- 24° beam angles.

IP 40 A+

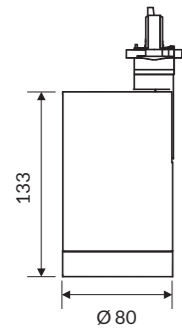
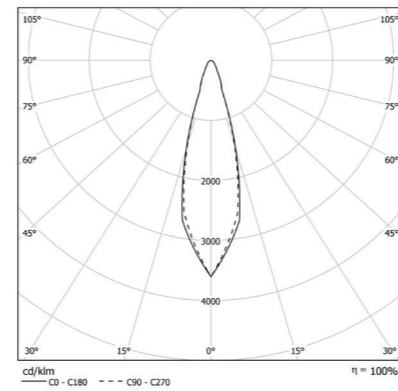

COLOUR TEMPERATURE //

4000 K

COD		lm
14PC13L412S	13W 12° 4000K	1239
14PC13L424S	13W 24° 4000K	1239
14PC18L412S	18W 12° 4000K	1715
14PC18L424S	18W 24° 4000K	1715

3000 K

COD		lm
14PC13L312S	13W 12° 3000K	1187
14PC13L324S	13W 24° 3000K	1187
14PC18L312S	18W 12° 3000K	1644
14PC18L324S	18W 24° 3000K	1644



TERES PC SMALL Premium CRI > 90



TERES

OPTIC

Polycarbonate lens: 12°- 24° beam angles.

IP 40 A+

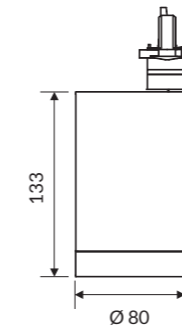
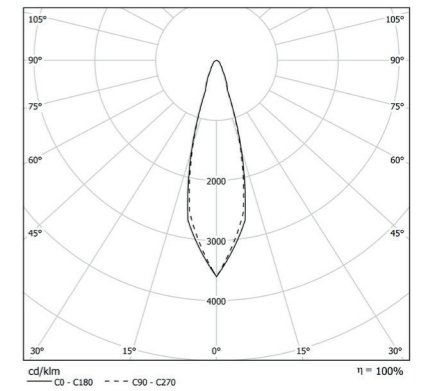

COLOUR TEMPERATURE //

4000 K

COD		lm
14PC13L412S90	13W 12° 4000K	1072
14PC13L424S90	13W 24° 4000K	1072
14PC18L412S90	18W 12° 4000K	1485
14PC18L424S90	18W 24° 4000K	1485

3000 K

COD		lm
14PC13L312S90	13W 12° 3000K	1020
14PC13L324S90	13W 24° 3000K	1020
14PC18L312S90	18W 12° 3000K	1413
14PC18L324S90	18W 24° 3000K	1413



TERES PC MEDIUM



OPTIC

Polycarbonate lens: 12°- 24° beam angles.

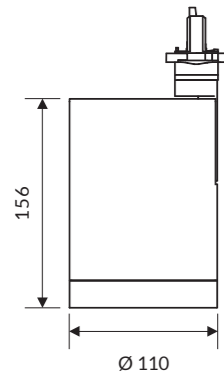

IP 40 A+

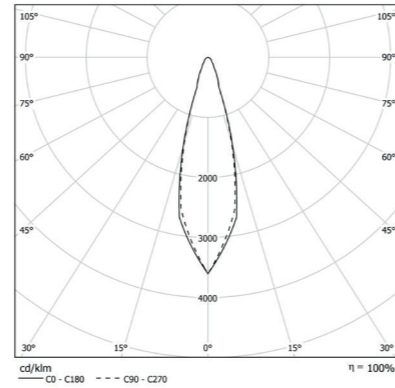

COLOUR TEMPERATURE //

4 0 0 0 K

COD		lm
14PC18L412M	18W 12° 4000K	2490
14PC18L424M	18W 24° 4000K	2490
14PC25L412M	25W 12° 4000K	3388
14PC25L424M	25W 24° 4000K	3388
14PC33L412M	33W 12° 4000K	4472
14PC33L424M	33W 24° 4000K	4472

3 0 0 0 K

COD		lm
14PC18L312M	18W 12° 3000K	2409
14PC18L324M	18W 24° 3000K	2409
14PC25L312M	25W 12° 3000K	3277
14PC25L324M	25W 24° 3000K	3277
14PC33L312M	33W 12° 3000K	4326
14PC33L324M	33W 24° 3000K	4326



TERES PC MEDIUM Premium CRI > 90



TERES

OPTIC

Polycarbonate lens: 12°- 24° beam angles.

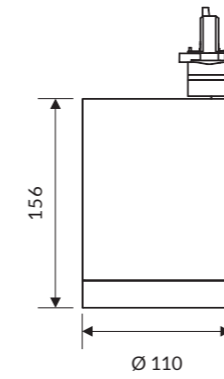

IP 40 A+

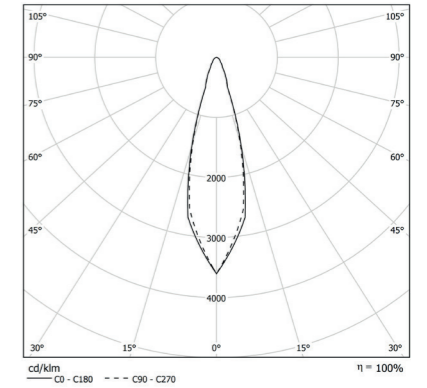

COLOUR TEMPERATURE //

4 0 0 0 K

COD		lm
14PC18L412M90	18W 12° 4000K	2051
14PC18L424M90	18W 24° 4000K	2051
14PC25L412M90	25W 12° 4000K	2790
14PC25L424M90	25W 24° 4000K	2790
14PC33L412M90	33W 12° 4000K	3683
14PC33L424M90	33W 24° 4000K	3683

3 0 0 0 K

COD		lm
14PC18L312M90	18W 12° 3000K	1985
14PC18L324M90	18W 24° 3000K	1985
14PC25L312M90	25W 12° 3000K	2701
14PC25L324M90	25W 24° 3000K	2701
14PC33L312M90	33W 12° 3000K	3566
14PC33L324M90	33W 24° 3000K	3566



TERES ZOOM SMALL Premium CRI > 90

OPTIC

Internal aluminum reflector:
adjustable emission from 25° to 60°.

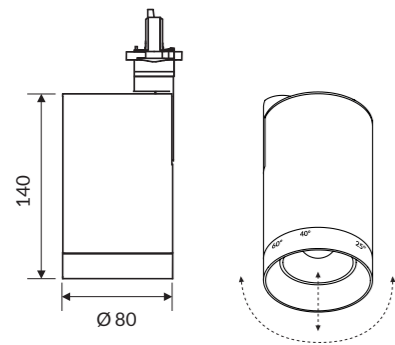

IP 40 A+

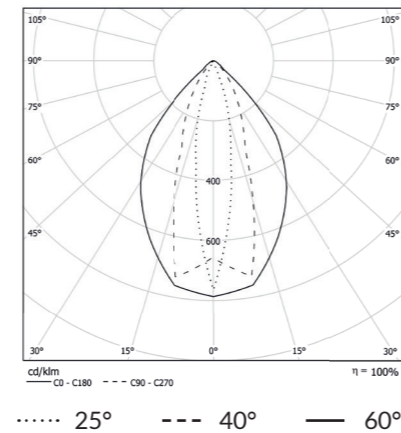

COLOUR TEMPERATURE //

4000 K

COD		lm
14ZM13L4S90	13W 4000K	1634

3000 K

COD		lm
14ZM13L3S90	13W 3000K	1485



TERES ZOOM MEDIUM Premium CRI > 90

OPTIC

Internal aluminum reflector:
adjustable emission from 25° to 60°.

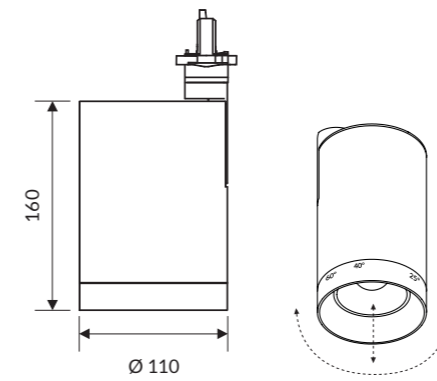

IP 40 A+

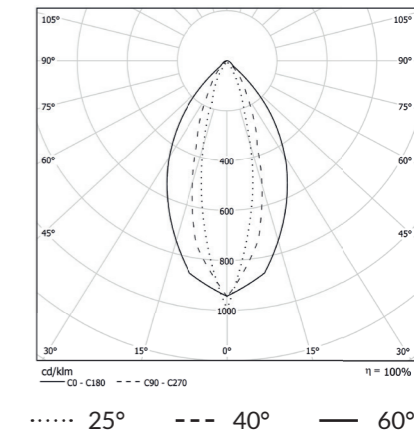

COLOUR TEMPERATURE //

4000 K

COD		lm
14ZM18L4M90	18W 4000K	2182
14ZM25L4M90	25W 4000K	3031
14ZM33L4M90	33W 4000K	3380

3000 K

COD		lm
14ZM18L3M90	18W 3000K	2040
14ZM25L3M90	25W 3000K	2833
14ZM33L3M90	33W 3000K	3130

TERES





TERES HF VT Premium CRI > 90



OPTIC

Internal aluminum reflectors:
10°- 20°- 40° - 70° beam angles.

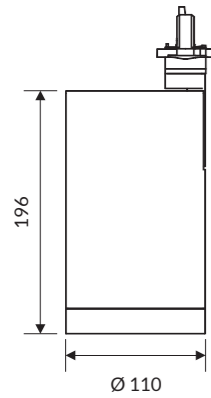

IP 20 A+

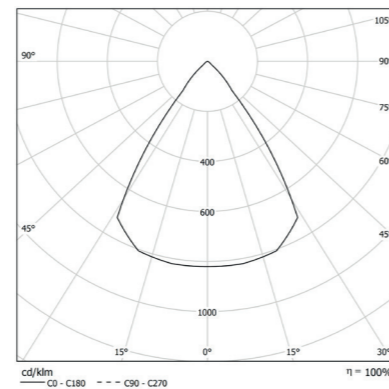

COLOUR TEMPERATURE //

4000 K

COD	Light Icon	lm
14VT36L410HF90	36W 10° 4000K	4091
14VT36L420HF90	36W 20° 4000K	4091
14VT36L440HF90	36W 40° 4000K	4091
14VT36L470HF90	36W 70° 4000K	4091
14VT42L410HF90	42W 10° 4000K	4873
14VT42L420HF90	42W 20° 4000K	4873
14VT42L440HF90	42W 40° 4000K	4873
14VT42L470HF90	42W 70° 4000K	4873
14VT50L410HF90	50W 10° 4000K	5243
14VT50L420HF90	50W 20° 4000K	5243
14VT50L440HF90	50W 40° 4000K	5243
14VT50L470HF90	50W 70° 4000K	5243

3000 K

COD	Light Icon	lm
14VT36L310HF90	36W 10° 3000K	3719
14VT36L320HF90	36W 20° 3000K	3719
14VT36L340HF90	36W 40° 3000K	3719
14VT36L370HF90	36W 70° 3000K	3719
14VT42L310HF90	42W 10° 3000K	4440
14VT42L320HF90	42W 20° 3000K	4440
14VT42L340HF90	42W 40° 3000K	4440
14VT42L370HF90	42W 70° 3000K	4440
14VT50L310HF90	50W 10° 3000K	4774
14VT50L320HF90	50W 20° 3000K	4774
14VT50L340HF90	50W 40° 3000K	4774
14VT50L370HF90	50W 70° 3000K	4774



TERES MEDIUM Food



TERES

OPTIC

Internal aluminum reflectors:
10°- 20°- 40° - 70° beam angles.

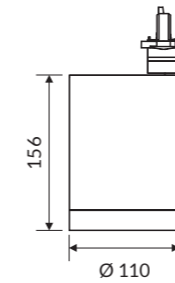

IP 40 A+

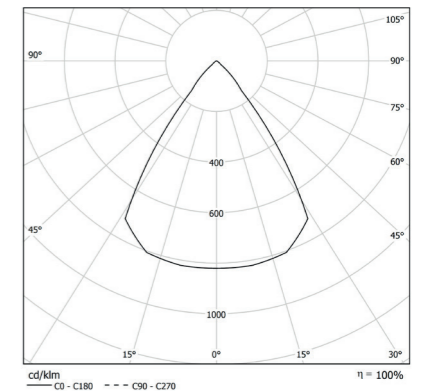

SPECIALIZED LED MODULES

- BREAD: the shades of brown appear sharper and brighter; they as strong as gold making the appearance of cheeses and bakery goods better.
- MEAT / FRESH MEAT: the red tones are very strong, for a fresh and inviting presentation of red meats and charcuterie.
- FISH: the colours are vivid and attractive, the fish is bright and colourful; the cool tones of the light enhance the freshness and brilliance of the fish.

OTHER APPLICATIONS

- CRI>90 Premium version with 3000K / 4000K colour temperature fixtures, are used to enhance the natural colour of the products and are suitable to light fruit and wine departments.

COD	Light Icon	lm
14VT31BR10M	31W 10° BREAD	2061
14VT31BR20M	31W 20° BREAD	2061
14VT31BR40M	31W 40° BREAD	2061
14VT31BR70M	31W 70° BREAD	2061
14VT31MT10M	31W 10° MEAT	1527
14VT31MT20M	31W 20° MEAT	1527
14VT31MT40M	31W 40° MEAT	1527
14VT31MT70M	31W 70° MEAT	1527
14VT31FH10M	31W 10° FISH	2228
14VT31FH20M	31W 20° FISH	2228
14VT31FH40M	31W 40° FISH	2228
14VT31FH70M	31W 70° FISH	2228

ACCESSORIES

ANTI-GLARE RINGS

Anti-glare rings that allow to focus the light beam hiding the light source. They perfectly fit in art galleries, museums and retail areas to value the subject with accent light without annoying glare issues.



FR60AGW: Teres Mini
White RAL 9003 ring.

FR60AGWBK: Teres Mini
White RAL 9003 ring with black RAL 9005 interior.

FR60AGBK: Teres Mini
Black RAL 9005 ring.

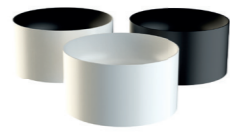

FR80AGW: Teres Small
White RAL 9003 ring.

FR80AGWBK: Teres Small
White RAL 9003 ring with black RAL 9005 interior.

FR80AGBK: Teres Small
Black RAL 9005 ring.



FR110AGW: Teres Medium e HF
White RAL 9003 ring.

FR110AGWBK: Teres Medium e HF
White RAL 9003 ring with black RAL 9005 interior.

FR110AGBK: Teres Medium e HF
Black RAL 9005 ring.

TECHNICAL NOTE

BODY ROTATION

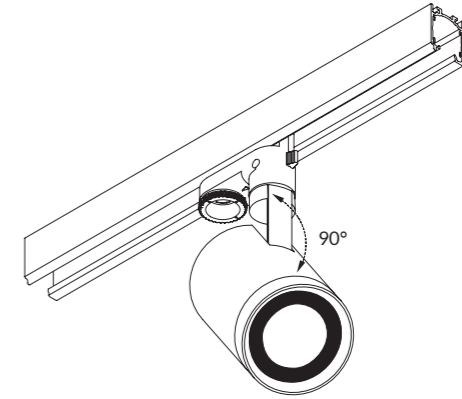
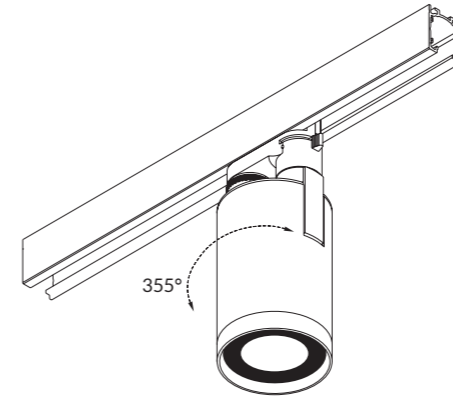

TERES VT OPTICS



14AAMGS
TERES VT SMALL
Mat Glass.



14AASLS
TERES VT SMALL
Sculpture optic.



14AANDS
TERES VT SMALL
Honeycomb optic.



14AAMGM
TERES VT MEDIUM
Mat Glass.



14AASLM
TERES VT MEDIUM
Sculpture optic.



14AANDM
TERES VT MEDIUM
Honeycomb optic.