



/ 500

TERES EXTE

5017

TERES EXTE

Design ESSE-CI



η >95 lm/W; >130 lm/W

CRI >80; >90

IP 40

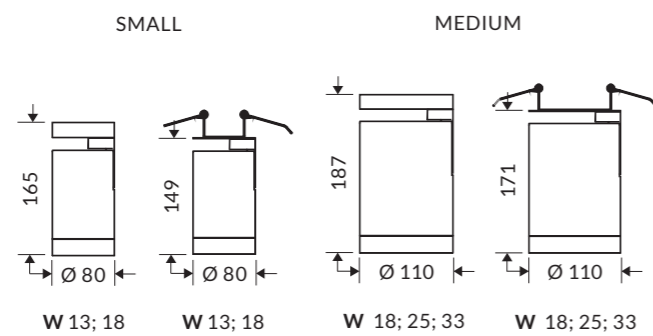



TERES EXTE

Born from Teres, TERES EXTE is the innovative spotlight for ceiling and recessed installation. Thanks to the driver hidden in the lamp body, it's suitable for all situations and catch for its minimalist design and purity of shapes. It can create a perfect harmony between general lighting and fine light accent.

SPECIFICATIONS

- Integrated driver
- Colour temperature: 3000K/4000K
- CRI>80; CRI>90
- McAdams 3
- Life Time: L80/B50 >50.000h
- 5 years complete warranty
- Eye safety: risk-free (RG 0) in accordance with EN62471:2009

OPTICS

- VT reflectors from 10° - 20° - 40° - 50° - 70° beam angles
- PC polycarbonate lens from 12° - 24° beam angles
- Mat glass
- Sculpture optic
- Honeycomb optic

BODY

Manufactured from pressure die-cast aluminum with epoxy powder coating.

LEGAL REFERENCES

In compliance with the safety standards EN 60 598-1 and UNI EN 12464-1 (lighting for working places).

CERTIFICATIONS

CE IP40
ErP Class: A+

COLOURS

White RAL 9003 wrinkled - Code: W
Black RAL 9005 wrinkled - Code: BK

ON REQUEST

- Colour temperature 2700K/5000K
- Wiring DALI dimmable - Code: RDD (verify the version available)
- Driver Bluetooth - Code: BT (available for MEDIUM version)

VERSIONS

- | | |
|---------------------------------------|---------------------------------------|
| TERES EXTE VT CEILING SMALL | TERES EXTE PC CEILING SMALL PREMIUM |
| TERES EXTE VT CEILING SMALL PREMIUM | TERES EXTE PC CEILING MEDIUM |
| TERES EXTE VT CEILING MEDIUM | TERES EXTE PC CEILING MEDIUM PREMIUM |
| TERES EXTE VT CEILING MEDIUM PREMIUM | TERES EXTE PC RECESSED SMALL |
| TERES EXTE VT RECESSED SMALL | TERES EXTE PC RECESSED SMALL PREMIUM |
| TERES EXTE VT RECESSED SMALL PREMIUM | TERES EXTE PC RECESSED MEDIUM |
| TERES EXTE VT RECESSED MEDIUM | TERES EXTE PC RECESSED MEDIUM PREMIUM |
| TERES EXTE VT RECESSED MEDIUM PREMIUM | ACCESSORIES |
| TERES EXTE PC CEILING SMALL | |



/ 5 0 4

TERES EXTE VT CEILING SMALL



OPTIC

Internal aluminum reflectors:
10°- 20°- 40° - 50° beam angles.

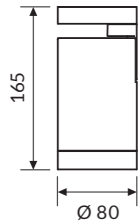

IP 40 A+

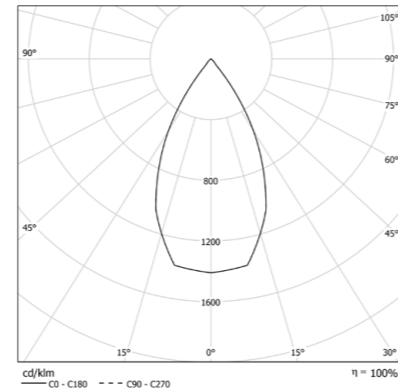

COLOUR TEMPERATURE //

4 0 0 0 K

COD		lm
14VT13L410SP	13W 10° 4000K	1239
14VT13L420SP	13W 20° 4000K	1239
14VT13L440SP	13W 40° 4000K	1239
14VT13L450SP	13W 50° 4000K	1239
14VT18L410SP	18W 10° 4000K	1715
14VT18L420SP	18W 20° 4000K	1715
14VT18L440SP	18W 40° 4000K	1715
14VT18L450SP	18W 50° 4000K	1715

3 0 0 0 K

COD		lm
14VT13L310SP	13W 10° 3000K	1187
14VT13L320SP	13W 20° 3000K	1187
14VT13L340SP	13W 40° 3000K	1187
14VT13L350SP	13W 50° 3000K	1187
14VT18L310SP	18W 10° 3000K	1644
14VT18L320SP	18W 20° 3000K	1644
14VT18L340SP	18W 40° 3000K	1644
14VT18L350SP	18W 50° 3000K	1644



5 0 5 /

TERES EXTE

TERES EXTE VT CEILING SMALL Premium CRI > 90



OPTIC

Internal aluminum reflectors:
10°- 20°- 40° - 50° beam angles.



IP 40 A+

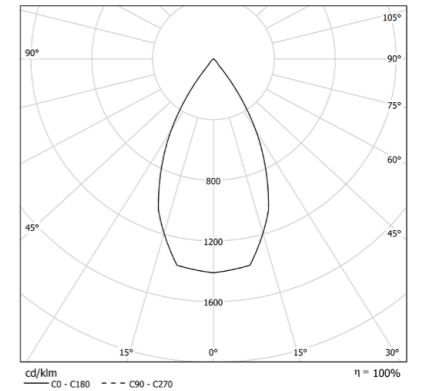

COLOUR TEMPERATURE //

4 0 0 0 K

COD		lm
14VT13L410SP90	13W 10° 4000K	1072
14VT13L420SP90	13W 20° 4000K	1072
14VT13L440SP90	13W 40° 4000K	1072
14VT13L450SP90	13W 50° 4000K	1072
14VT18L410SP90	18W 10° 4000K	1485
14VT18L420SP90	18W 20° 4000K	1485
14VT18L440SP90	18W 40° 4000K	1485
14VT18L450SP90	18W 50° 4000K	1485

3 0 0 0 K

COD		lm
14VT13L310SP90	13W 10° 3000K	1020
14VT13L320SP90	13W 20° 3000K	1020
14VT13L340SP90	13W 40° 3000K	1020
14VT13L350SP90	13W 50° 3000K	1020
14VT18L310SP90	18W 10° 3000K	1413
14VT18L320SP90	18W 20° 3000K	1413
14VT18L340SP90	18W 40° 3000K	1413
14VT18L350SP90	18W 50° 3000K	1413



/ 5 0 6

TERES EXTE VT CEILING MEDIUM

OPTIC

Internal aluminum reflectors:
10°- 20°- 40° - 70° beam angles.

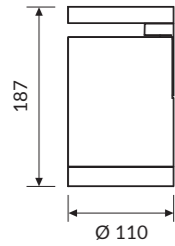

IP 40 A+

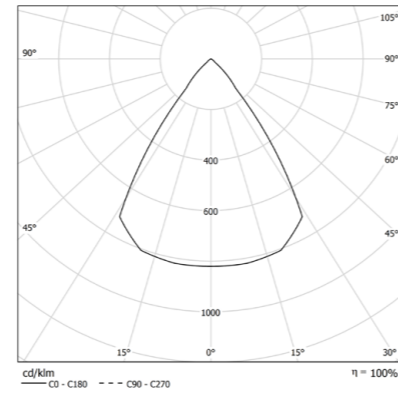

COLOUR TEMPERATURE //

4 0 0 0 K

COD	💡	lm
14VT18L410MP	18W 10° 4000K	2490
14VT18L420MP	18W 20° 4000K	2490
14VT18L440MP	18W 40° 4000K	2490
14VT18L470MP	18W 70° 4000K	2490
14VT25L410MP	25W 10° 4000K	3388
14VT25L420MP	25W 20° 4000K	3388
14VT25L440MP	25W 40° 4000K	3388
14VT25L470MP	25W 70° 4000K	3388
14VT33L410MP	33W 10° 4000K	4472
14VT33L420MP	33W 20° 4000K	4472
14VT33L440MP	33W 40° 4000K	4472
14VT33L470MP	33W 70° 4000K	4472

3 0 0 0 K

COD	💡	lm
14VT18L310MP	18W 10° 3000K	2409
14VT18L320MP	18W 20° 3000K	2409
14VT18L340MP	18W 40° 3000K	2409
14VT18L370MP	18W 70° 3000K	2409
14VT25L310MP	25W 10° 3000K	3277
14VT25L320MP	25W 20° 3000K	3277
14VT25L340MP	25W 40° 3000K	3277
14VT25L370MP	25W 70° 3000K	3277
14VT33L310MP	33W 10° 3000K	4326
14VT33L320MP	33W 20° 3000K	4326
14VT33L340MP	33W 40° 3000K	4326
14VT33L370MP	33W 70° 3000K	4326



TERES EXTE

5 0 7 /

TERES EXTE VT CEILING MEDIUM Premium CRI > 90

OPTIC

Internal aluminum reflectors:
10°- 20°- 40° - 70° beam angles.

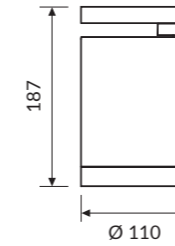

IP 40 A+

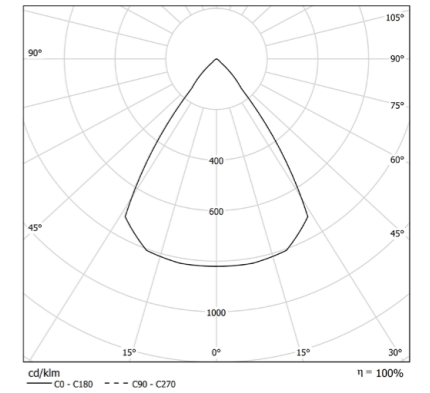

COLOUR TEMPERATURE //

4 0 0 0 K

COD	💡	lm
14VT18L410MP90	18W 10° 4000K	2051
14VT18L420MP90	18W 20° 4000K	2051
14VT18L440MP90	18W 40° 4000K	2051
14VT18L470MP90	18W 70° 4000K	2051
14VT25L410MP90	25W 10° 4000K	2790
14VT25L420MP90	25W 20° 4000K	2790
14VT25L440MP90	25W 40° 4000K	2790
14VT25L470MP90	25W 70° 4000K	2790
14VT33L410MP90	33W 10° 4000K	3683
14VT33L420MP90	33W 20° 4000K	3683
14VT33L440MP90	33W 40° 4000K	3683
14VT33L470MP90	33W 70° 4000K	3683

3 0 0 0 K

COD	💡	lm
14VT18L310MP90	18W 10° 3000K	1985
14VT18L320MP90	18W 20° 3000K	1985
14VT18L340MP90	18W 40° 3000K	1985
14VT18L370MP90	18W 70° 3000K	1985
14VT25L310MP90	25W 10° 3000K	2701
14VT25L320MP90	25W 20° 3000K	2701
14VT25L340MP90	25W 40° 3000K	2701
14VT25L370MP90	25W 70° 3000K	2701
14VT33L310MP90	33W 10° 3000K	3566
14VT33L320MP90	33W 20° 3000K	3566
14VT33L340MP90	33W 40° 3000K	3566
14VT33L370MP90	33W 70° 3000K	3566



/ 5 0 8

TERES EXTE VT RECESSED SMALL



OPTIC

Internal aluminum reflectors:
10°- 20°- 40° - 50° beam angles.

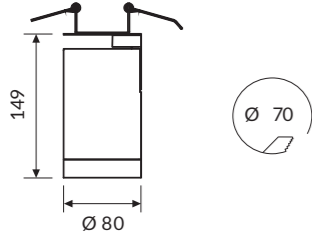

IP 40 A+

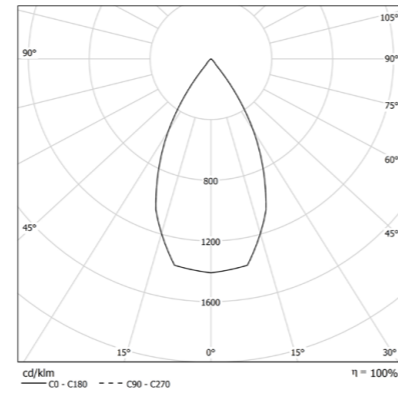

COLOUR TEMPERATURE //

4 0 0 0 K

COD	💡	lm
14VT13L410SR	13W 10° 4000K	1239
14VT13L420SR	13W 20° 4000K	1239
14VT13L440SR	13W 40° 4000K	1239
14VT13L450SR	13W 50° 4000K	1239
14VT18L410SR	18W 10° 4000K	1715
14VT18L420SR	18W 20° 4000K	1715
14VT18L440SR	18W 40° 4000K	1715
14VT18L450SR	18W 50° 4000K	1715

3 0 0 0 K

COD	💡	lm
14VT13L310SR	13W 10° 3000K	1187
14VT13L320SR	13W 20° 3000K	1187
14VT13L340SR	13W 40° 3000K	1187
14VT13L350SR	13W 50° 3000K	1187
14VT18L310SR	18W 10° 3000K	1644
14VT18L320SR	18W 20° 3000K	1644
14VT18L340SR	18W 40° 3000K	1644
14VT18L350SR	18W 50° 3000K	1644



TERES EXTE

5 0 9 /

TERES EXTE VT RECESSED SMALL Premium CRI > 90



OPTIC

Internal aluminum reflectors:
10°- 20°- 40° - 50° beam angles.

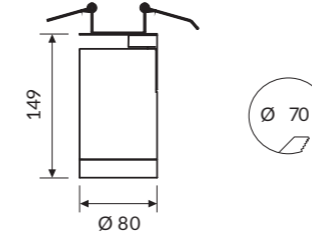

IP 40 A+

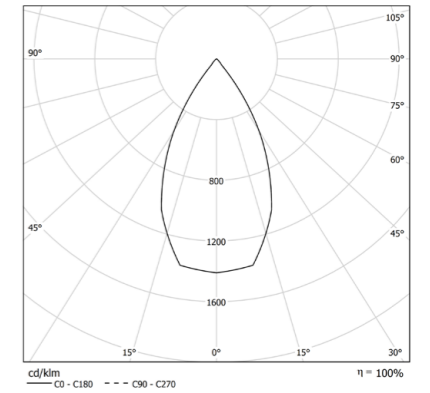

COLOUR TEMPERATURE //

4 0 0 0 K

COD	💡	lm
14VT13L410SR90	13W 10° 4000K	1072
14VT13L420SR90	13W 20° 4000K	1072
14VT13L440SR90	13W 40° 4000K	1072
14VT13L450SR90	13W 50° 4000K	1072
14VT18L410SR90	18W 10° 4000K	1485
14VT18L420SR90	18W 20° 4000K	1485
14VT18L440SR90	18W 40° 4000K	1485
14VT18L450SR90	18W 50° 4000K	1485

3 0 0 0 K

COD	💡	lm
14VT13L310SR90	13W 10° 3000K	1020
14VT13L320SR90	13W 20° 3000K	1020
14VT13L340SR90	13W 40° 3000K	1020
14VT13L350SR90	13W 50° 3000K	1020
14VT18L310SR90	18W 10° 3000K	1413
14VT18L320SR90	18W 20° 3000K	1413
14VT18L340SR90	18W 40° 3000K	1413
14VT18L350SR90	18W 50° 3000K	1413



/ 5 1 0

TERES EXTE VT RECESSED MEDIUM

OPTIC

Internal aluminum reflectors:
10°- 20°- 40° - 70° beam angles.

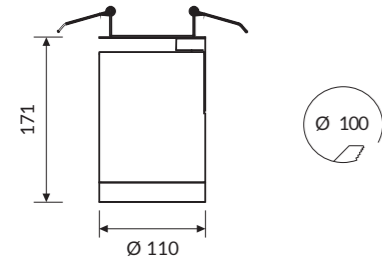

IP 40 A*

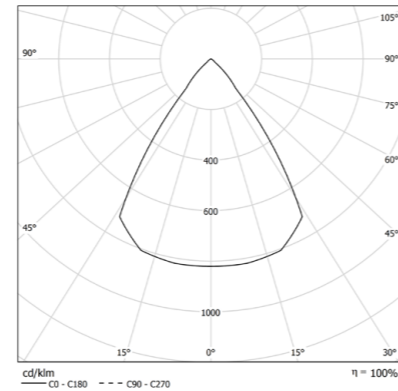

5 1 1 /

TERES EXTE VT RECESSED MEDIUM Premium CRI > 90

OPTIC

Internal aluminum reflectors:
10°- 20°- 40° - 70° beam angles.

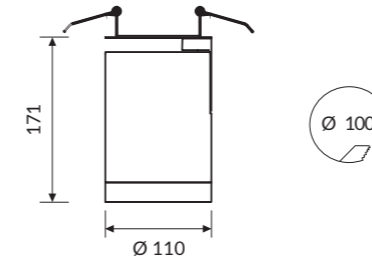

IP 40 A*

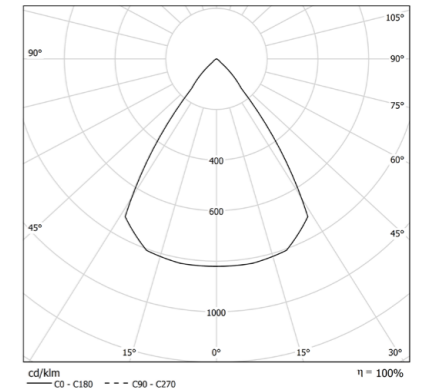

COLOUR TEMPERATURE //

4 0 0 0 K

COD	💡	lm
14VT18L410MR	18W 10° 4000K	2490
14VT18L420MR	18W 20° 4000K	2490
14VT18L440MR	18W 40° 4000K	2490
14VT18L470MR	18W 70° 4000K	2490
14VT25L410MR	25W 10° 4000K	3388
14VT25L420MR	25W 20° 4000K	3388
14VT25L440MR	25W 40° 4000K	3388
14VT25L470MR	25W 70° 4000K	3388
14VT33L410MR	33W 10° 4000K	4472
14VT33L420MR	33W 20° 4000K	4472
14VT33L440MR	33W 40° 4000K	4472
14VT33L470MR	33W 70° 4000K	4472

3 0 0 0 K

COD	💡	lm
14VT18L310MR	18W 10° 3000K	2409
14VT18L320MR	18W 20° 3000K	2409
14VT18L340MR	18W 40° 3000K	2409
14VT18L370MR	18W 70° 3000K	2409
14VT25L310MR	25W 10° 3000K	3277
14VT25L320MR	25W 20° 3000K	3277
14VT25L340MR	25W 40° 3000K	3277
14VT25L370MR	25W 70° 3000K	3277
14VT33L310MR	33W 10° 3000K	4326
14VT33L320MR	33W 20° 3000K	4326
14VT33L340MR	33W 40° 3000K	4326
14VT33L370MR	33W 70° 3000K	4326

COLOUR TEMPERATURE //

4 0 0 0 K

COD	💡	lm
14VT18L410MR90	18W 10° 4000K	2051
14VT18L420MR90	18W 20° 4000K	2051
14VT18L440MR90	18W 40° 4000K	2051
14VT18L470MR90	18W 70° 4000K	2051
14VT25L410MR90	25W 10° 4000K	2790
14VT25L420MR90	25W 20° 4000K	2790
14VT25L440MR90	25W 40° 4000K	2790
14VT25L470MR90	25W 70° 4000K	2790
14VT33L410MR90	33W 10° 4000K	3683
14VT33L420MR90	33W 20° 4000K	3683
14VT33L440MR90	33W 40° 4000K	3683
14VT33L470MR90	33W 70° 4000K	3683

3 0 0 0 K

COD	💡	lm
14VT18L310MR90	18W 10° 3000K	1985
14VT18L320MR90	18W 20° 3000K	1985
14VT18L340MR90	18W 40° 3000K	1985
14VT18L370MR90	18W 70° 3000K	1985
14VT25L310MR90	25W 10° 3000K	2701
14VT25L320MR90	25W 20° 3000K	2701
14VT25L340MR90	25W 40° 3000K	2701
14VT25L370MR90	25W 70° 3000K	2701
14VT33L310MR90	33W 10° 3000K	3566
14VT33L320MR90	33W 20° 3000K	3566
14VT33L340MR90	33W 40° 3000K	3566
14VT33L370MR90	33W 70° 3000K	3566



/ 5 1 2

TERES EXTE PC CEILING SMALL



OPTIC

Polycarbonate lens: 12°- 24° beam angles.

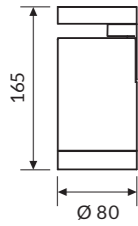

IP 40 A+

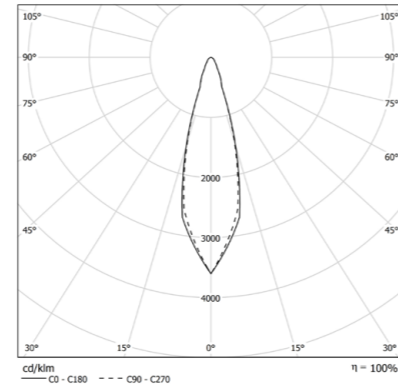

COLOUR TEMPERATURE //

4 0 0 0 K

COD		lm
14PC13L412SP	13W 12° 4000K	1239
14PC13L424SP	13W 24° 4000K	1239
14PC18L412SP	18W 12° 4000K	1715
14PC18L424SP	18W 24° 4000K	1715

3 0 0 0 K

COD		lm
14PC13L312SP	13W 12° 3000K	1187
14PC13L324SP	13W 24° 3000K	1187
14PC18L312SP	18W 12° 3000K	1644
14PC18L324SP	18W 24° 3000K	1644



5 1 3 /

TERES EXTE

TERES EXTE PC CEILING SMALL Premium CRI > 90



OPTIC

Polycarbonate lens: 12°- 24° beam angles.

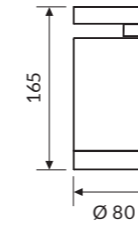

IP 40 A+

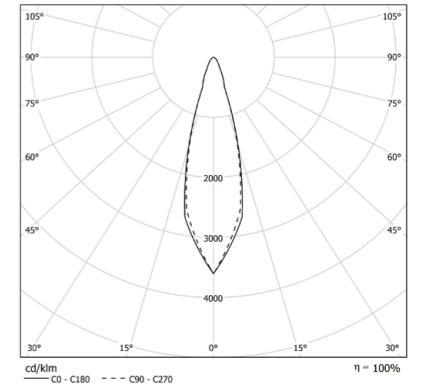

COLOUR TEMPERATURE //

4 0 0 0 K

COD		lm
14PC13L412SP90	13W 12° 4000K	1072
14PC13L424SP90	13W 24° 4000K	1072
14PC18L412SP90	18W 12° 4000K	1485
14PC18L424SP90	18W 24° 4000K	1485

3 0 0 0 K

COD		lm
14PC13L312SP90	13W 12° 3000K	1020
14PC13L324SP90	13W 24° 3000K	1020
14PC18L312SP90	18W 12° 3000K	1413
14PC18L324SP90	18W 24° 3000K	1413



/ 5 1 4

TERES EXTE PC CEILING MEDIUM

OPTIC

Polycarbonate lens: 12°- 24° beam angles.

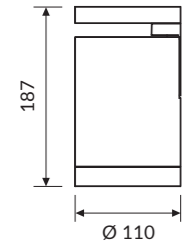

IP 40 A+

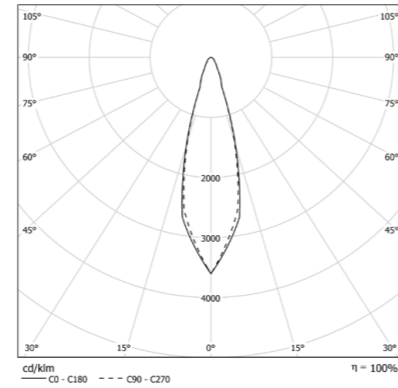

COLOUR TEMPERATURE //

4 0 0 0 K

COD		lm
14PC18L412MP	18W 12° 4000K	2490
14PC18L424MP	18W 24° 4000K	2490
14PC25L412MP	25W 12° 4000K	3388
14PC25L424MP	25W 24° 4000K	3388
14PC33L412MP	33W 12° 4000K	4472
14PC33L424MP	33W 24° 4000K	4472

3 0 0 0 K

COD		lm
14PC18L312MP	18W 12° 3000K	2409
14PC18L324MP	18W 24° 3000K	2409
14PC25L312MP	25W 12° 3000K	3277
14PC25L324MP	25W 24° 3000K	3277
14PC33L312MP	33W 12° 3000K	4326
14PC33L324MP	33W 24° 3000K	4326



5 1 5 /

TERES EXTE PC CEILING MEDIUM Premium CRI > 90

OPTIC

Polycarbonate lens: 12°- 24° beam angles.

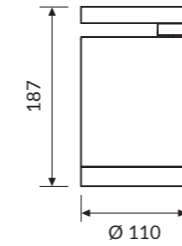

IP 40 A+

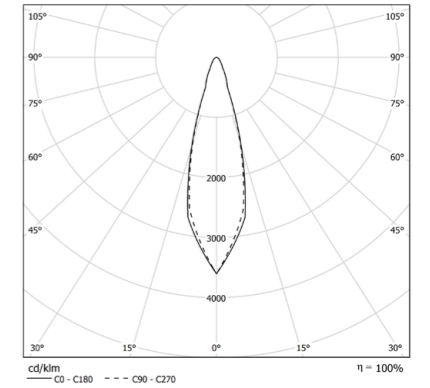

COLOUR TEMPERATURE //

4 0 0 0 K

COD		lm
14PC18L412MP90	18W 12° 4000K	2051
14PC18L424MP90	18W 24° 4000K	2051
14PC25L412MP90	25W 12° 4000K	2790
14PC25L424MP90	25W 24° 4000K	2790
14PC33L412MP90	33W 12° 4000K	3683
14PC33L424MP90	33W 24° 4000K	3683

3 0 0 0 K

COD		lm
14PC18L312MP90	18W 12° 3000K	1985
14PC18L324MP90	18W 24° 3000K	1985
14PC25L312MP90	25W 12° 3000K	2701
14PC25L324MP90	25W 24° 3000K	2701
14PC33L312MP90	33W 12° 3000K	3566
14PC33L324MP90	33W 24° 3000K	3566

TERES EXTE





/ 5 1 6

TERES EXTE PC RECESSED SMALL



OPTIC

Polycarbonate lens: 12°- 24° beam angles.

IP 40 A+

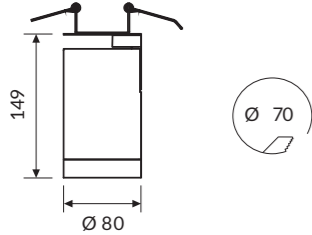
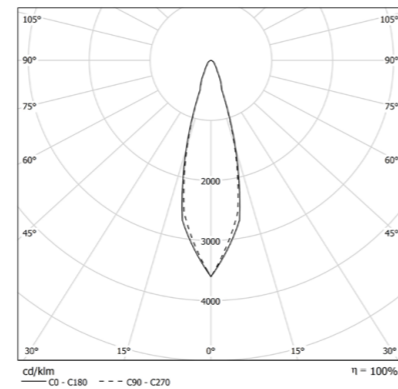

COLOUR TEMPERATURE //

4 0 0 0 K

COD		lm
14PC13L412SR	13W 12° 4000K	1239
14PC13L424SR	13W 24° 4000K	1239
14PC18L412SR	18W 12° 4000K	1715
14PC18L424SR	18W 24° 4000K	1715

3 0 0 0 K

COD		lm
14PC13L312SR	13W 12° 3000K	1187
14PC13L324SR	13W 24° 3000K	1187
14PC18L312SR	18W 12° 3000K	1644
14PC18L324SR	18W 24° 3000K	1644



5 1 7 /

TERES EXTE

TERES EXTE PC RECESSED SMALL Premium CRI > 90



OPTIC

Polycarbonate lens: 12°- 24° beam angles.

IP 40 A+

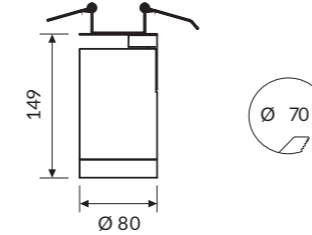
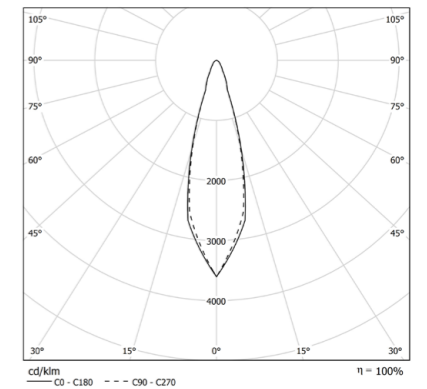

COLOUR TEMPERATURE //

4 0 0 0 K

COD		lm
14PC13L412SR90	13W 12° 4000K	1072
14PC13L424SR90	13W 24° 4000K	1072
14PC18L412SR90	18W 12° 4000K	1485
14PC18L424SR90	18W 24° 4000K	1485

3 0 0 0 K

COD		lm
14PC13L312SR90	13W 12° 3000K	1020
14PC13L324SR90	13W 24° 3000K	1020
14PC18L312SR90	18W 12° 3000K	1413
14PC18L324SR90	18W 24° 3000K	1413



/ 5 1 8

TERES EXTE PC RECESSED MEDIUM



OPTIC

Polycarbonate lens: 12°- 24° beam angles.

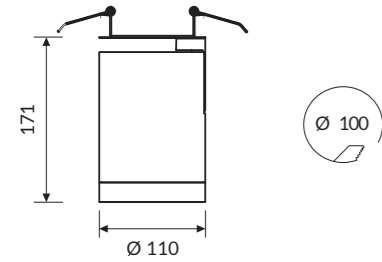

IP 40 A+

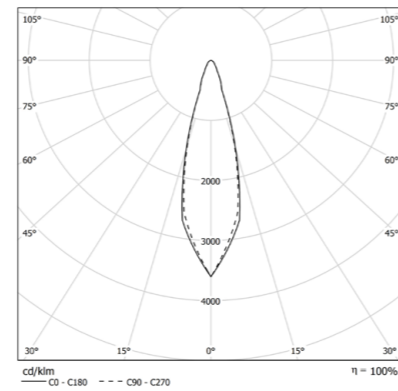

COLOUR TEMPERATURE //

4 0 0 0 K

COD	💡	lm
14PC18L412MR	18W 12° 4000K	2490
14PC18L424MR	18W 24° 4000K	2490
14PC25L412MR	25W 12° 4000K	3388
14PC25L424MR	25W 24° 4000K	3388
14PC33L412MR	33W 12° 4000K	4472
14PC33L424MR	33W 24° 4000K	4472

3 0 0 0 K

COD	💡	lm
14PC18L312MR	18W 12° 3000K	2409
14PC18L324MR	18W 24° 3000K	2409
14PC25L312MR	25W 12° 3000K	3277
14PC25L324MR	25W 24° 3000K	3277
14PC33L312MR	33W 12° 3000K	4326
14PC33L324MR	33W 24° 3000K	4326



5 1 9 /

TERES EXTE

TERES EXTE PC RECESSED MEDIUM Premium CRI > 90



OPTIC

Polycarbonate lens: 12°- 24° beam angles.

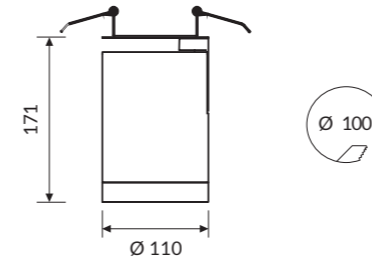

IP 40 A+

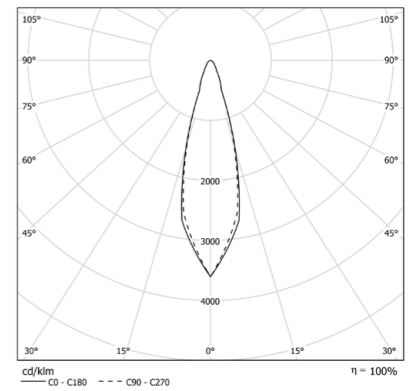

COLOUR TEMPERATURE //

4 0 0 0 K

COD	💡	lm
14PC18L412MR90	18W 12° 4000K	2051
14PC18L424MR90	18W 24° 4000K	2051
14PC25L412MR90	25W 12° 4000K	2790
14PC25L424MR90	25W 24° 4000K	2790
14PC33L412MR90	33W 12° 4000K	3683
14PC33L424MR90	33W 24° 4000K	3683

3 0 0 0 K

COD	💡	lm
14PC18L312MR90	18W 12° 3000K	1985
14PC18L324MR90	18W 24° 3000K	1985
14PC25L312MR90	25W 12° 3000K	2701
14PC25L324MR90	25W 24° 3000K	2701
14PC33L312MR90	33W 12° 3000K	3566
14PC33L324MR90	33W 24° 3000K	3566

ACCESSORIES

TERES EXTE VT OPTICS



14AAMGS

TERES EXTE VT SMALL
Mat Glass.



14AASLS

TERES EXTE VT SMALL
Sculpture optic.



14AANDS

TERES EXTE VT SMALL
Honeycomb optic.



14AAMGM

TERES EXTE VT MEDIUM
Mat Glass.



14AASLM

TERES EXTE VT MEDIUM
Sculpture optic.



14AANDM

TERES EXTE VT MEDIUM
Honeycomb optic.

TECHNICAL NOTE

BODY ROTATION

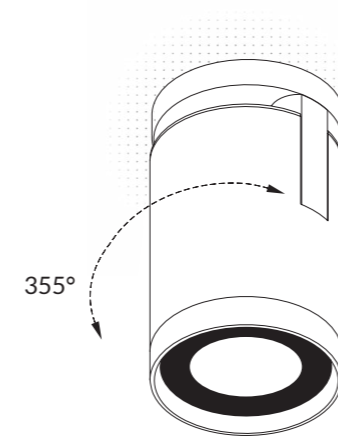

TERES EXTE CEILING

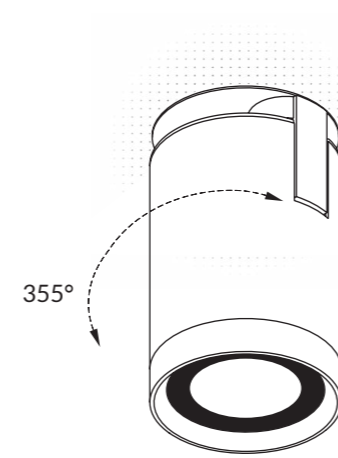
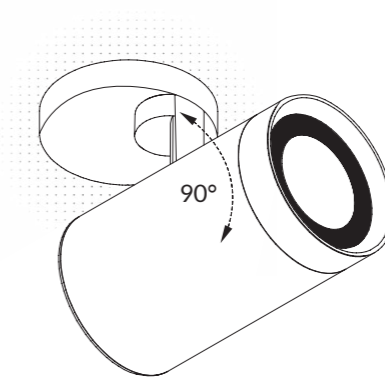

TERES EXTE RECESSED

