



/ 4 5 0

SEMPLICE

4 5 1 /

SEMPLICE

Design Quargnale // Ruatti studio Architetti

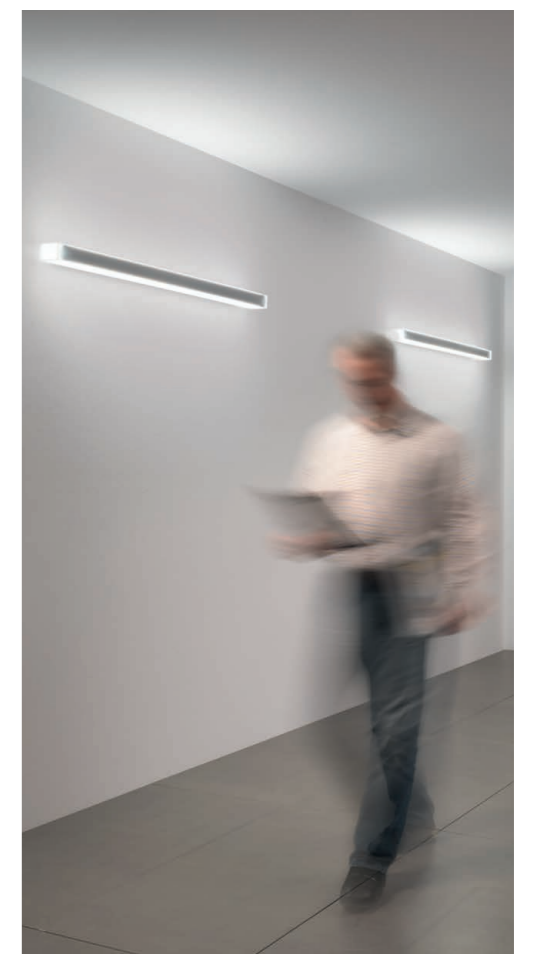
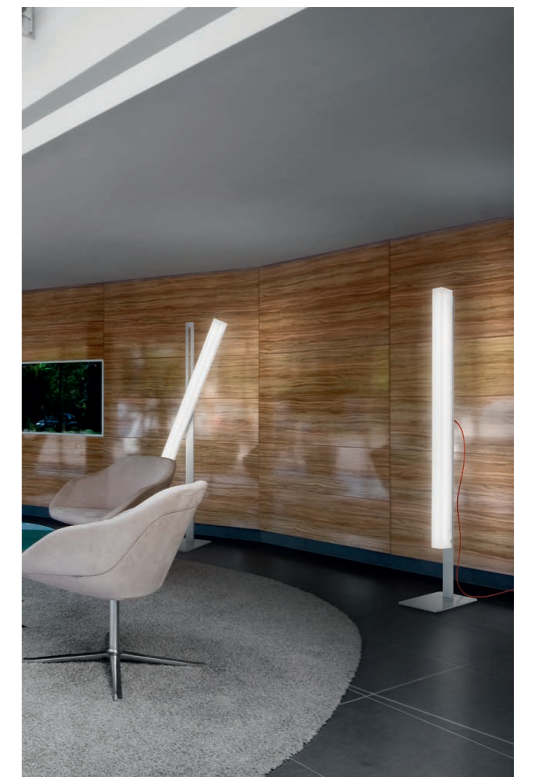

η >95 lm/W

CRI >80

IP 40

UGR <22

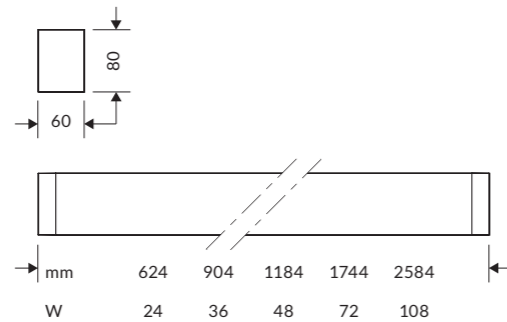



SEMPlice

SEMPlice is an innovative lighting solution suited to a wide range of interior applications including commercial, leisure and retail environments. Never before has a product been so versatile, with suspended or directly surface mounted versions available for wall and ceiling mounting. They can be individually installed, continuously mounted or even pattern formed using the tailored range of accessories. Unique in the fact that light is emitted in all directions including the ends, thanks to the integrated LED technology and translucent end caps. A broad collection matching products can be specified for free-standing and EUTrack mounting, giving the user continuity of product, but complete design freedom in a project.

SPECIFICATIONS

- 350mA integrated driver
- Colour temperature: 3000K/4000K
- CRI>80
- Mac Adams 3
- Life Time: L80/B50 >50.000h
- 5 years complete warranty
- Eye safety: risk-free (RG 0) in accordance with EN62471:2009

OPTICS

PG for soft and homogenous emission without areas of shade
EB for side emission

BODY

Body - diffuser manufactured from shock-resistant, anti-static technopolymer, with an exclusive paint treatment to guarantee constant soft light homogeneity. End caps and joint accessories are produced in the same material to ensure seamless lines of light.

LEGAL REFERENCES

In compliance with the safety standards EN 60 598-1 and UNI EN 12464-1 (lighting for working places).

CERTIFICATIONS

CE IP40
ErP Class: A++



ON REQUEST

- Wiring DALI dimmable - Code: RDD (verify the version available)
- Wiring with emergency kit - Code: EM for 1 hour / EM3H for 3 hours (verify the version available)
- Colour Temperature 5000K
- CRI>90 Premium Version
- Driver Bluetooth - Code: BT (verify the version available)

VERSIONS

SEMPlice LED PG
SEMPlice LED EB
SEMPlice LED EUTRACK

SEMPlice LED FLOOR
ACCESSORIES



/ 4 5 4

SEMPLICE LED P G

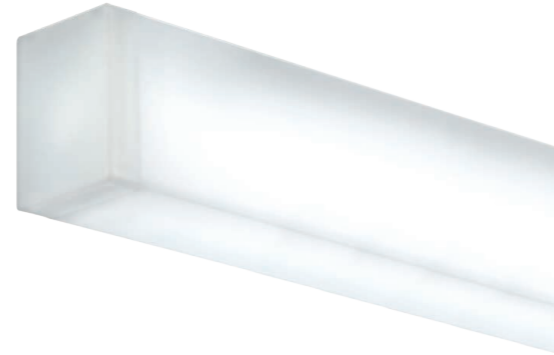

OPTIC

PMMA technopolymer with surface treatment for completely uniform light distribution. Integrated LED technology.

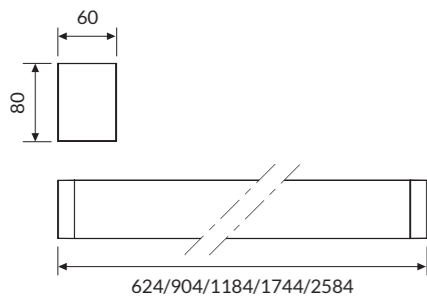

IP 40 A++

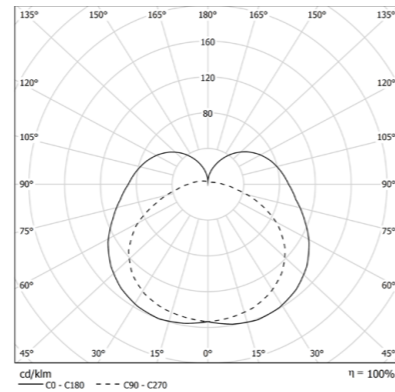

COLOUR TEMPERATURE //

4 0 0 0 K

COD		lm	mm
67PG24L4HP	24W 4000K	2243	624
67PG36L4HP	36W 4000K	3364	904
67PG48L4HP	48W 4000K	4486	1184
67PG72L4HP	72W 4000K	6728	1744
67PG108L4HP	108W 4000K	10093	2584

3 0 0 0 K

COD		lm	mm
67PG24L3HP	24W 3000K	2167	624
67PG36L3HP	36W 3000K	3251	904
67PG48L3HP	48W 3000K	4334	1184
67PG72L3HP	72W 3000K	6502	1744
67PG108L3HP	108W 3000K	9752	2584



4 5 5 /

SEMPLICE

SEMPLICE LED E B

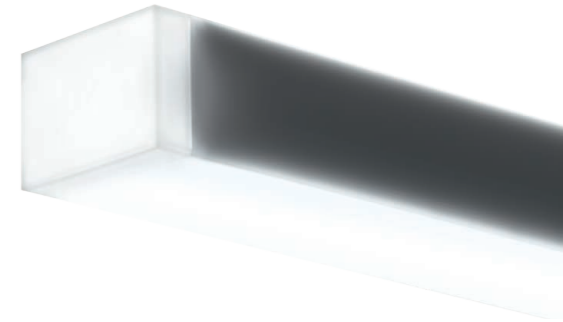

OPTIC

PMMA technopolymer with surface treatment and super-pure aluminum reflector for bi-directional light distribution. Integrated LED technology.

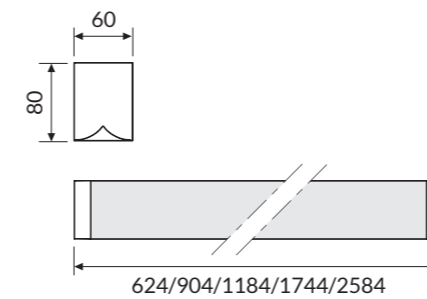

IP 40 A++

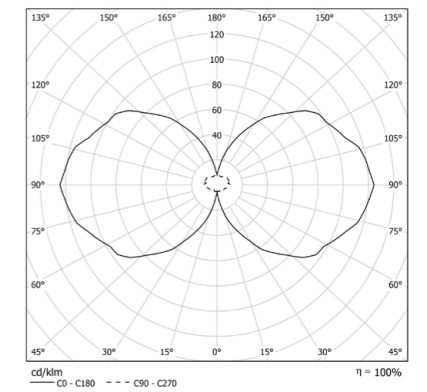

COLOUR TEMPERATURE //

4 0 0 0 K

COD		lm	mm
67EB24L4HP	24W 4000K	2016	624
67EB36L4HP	36W 4000K	3024	904
67EB48L4HP	48W 4000K	4032	1184
67EB72L4HP	72W 4000K	6048	1744
67EB108L4HP	108W 4000K	9072	2584

3 0 0 0 K

COD		lm	mm
67EB24L3HP	24W 3000K	1940	624
67EB36L3HP	36W 3000K	2911	904
67EB48L3HP	48W 3000K	3881	1184
67EB72L3HP	72W 3000K	5821	1744
67EB108L3HP	108W 3000K	8732	2584



/ 4 5 6

SEMPLICE LED EUTRACK



OPTIC

PMMA technopolymer with surface treatment for completely uniform light distribution. Integrated LED technology. Fitted with EUtrack connector.

IP40 A++

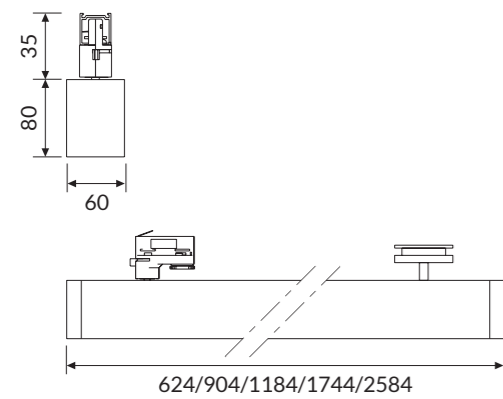
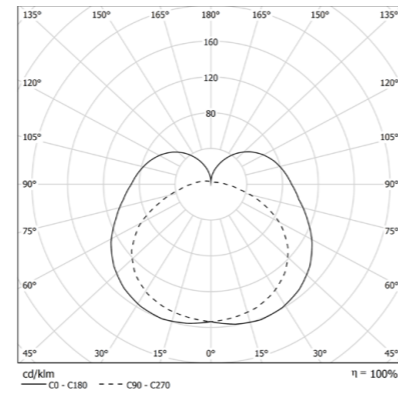

COLOUR TEMPERATURE //

4000 K

COD	💡	lm	mm
67PG24L4HPAB	24W 4000K	2243	624
67PG36L4HPAB	36W 4000K	3364	904
67PG48L4HPAB	48W 4000K	4486	1184
67PG72L4HPAB	72W 4000K	6728	1744
67PG108L4HPAB	108W 4000K	10093	2584

3000 K

COD	💡	lm	mm
67PG24L3HPAB	24W 3000K	2167	624
67PG36L3HPAB	36W 3000K	3251	904
67PG48L3HPAB	48W 3000K	4334	1184
67PG72L3HPAB	72W 3000K	6502	1744
67PG108L3HPAB	108W 3000K	9752	2584



SEMPLICE LED FLOOR



SEMPLICE

4 5 7 /

OPTIC

PMMA technopolymer with surface treatment for completely uniform light distribution. Supplied with a metal base with universal joint for head rotation.

IP40 A++

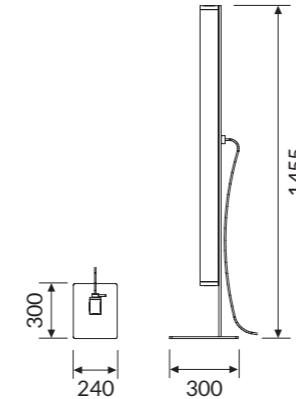
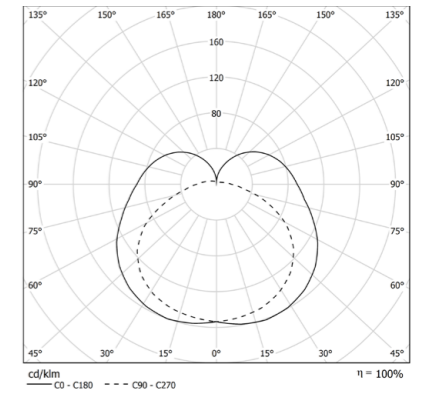

COLOUR TEMPERATURE //

4000 K

COD	💡	lm
67PG48L4HPT	48W 4000K	4272

3000 K

COD	💡	lm
67PG48L3HPT	48W 3000K	4128

ACCESSORIES



67AA13
Single wire 1500mm adjustable suspension kit.



67AA1330
Single wire 3000mm adjustable suspension kit.



67AA14
Spacers kit for wall/ceiling mounting.



67AA16
3-poles powered supply box. Cable length 2000mm.



67AA165P
5-poles powered supply box. Cable length 2000mm.



67AA11LED
Electrified linear joint with total emission for continuous rows installation.



67AA05
Internally electrified creative joint for horizontal change of direction.



67AA05V
Internally electrified 90° joint for vertical change of direction.

TECHNICAL NOTE

SEMPLICE FLOOR

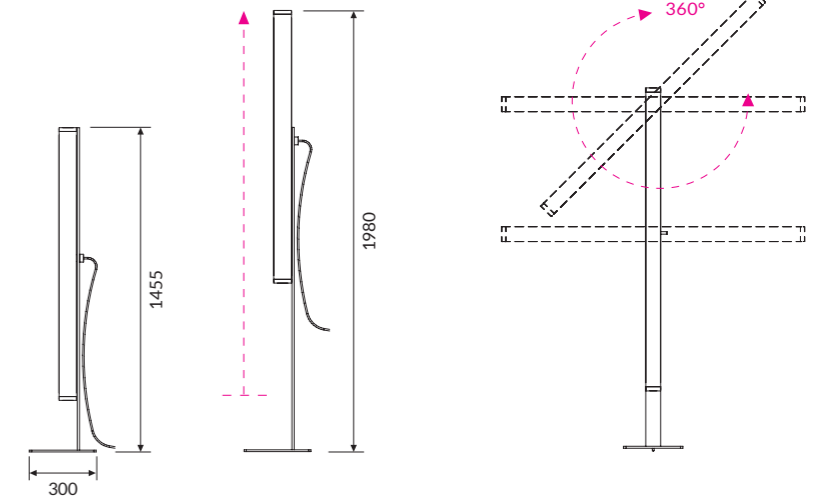
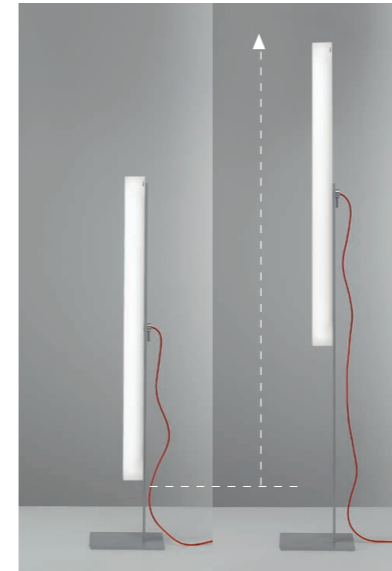

FIXING DISTANCES FOR SUSPENSION

💡	mm-min.	mm-max.
24W	300	450
36W	400	750
48W	600	1050
72W	800	1500
108W	1100	2240

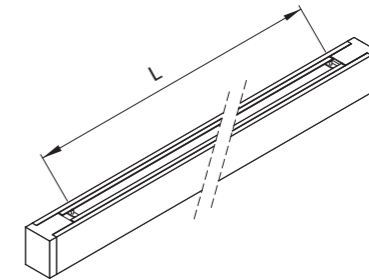

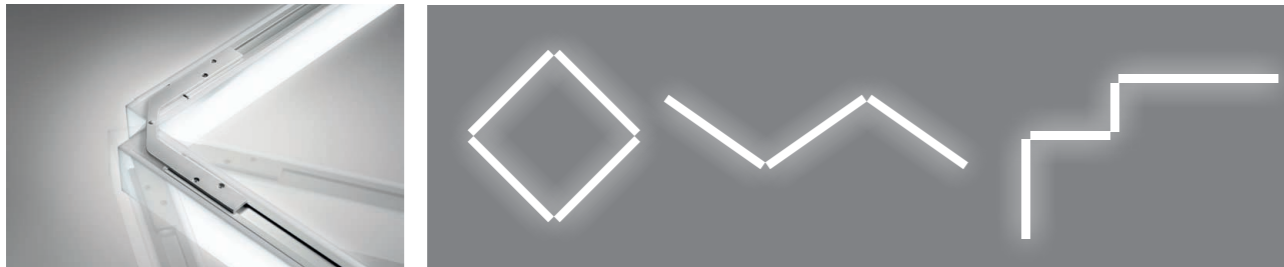

TECHNICAL NOTE**MODULAR SYSTEM**

The universal articulated joint is through-wired and facilitates the creation of unique shapes and pattern forms.

**SEMPLICE LED HCL****OPTIC**

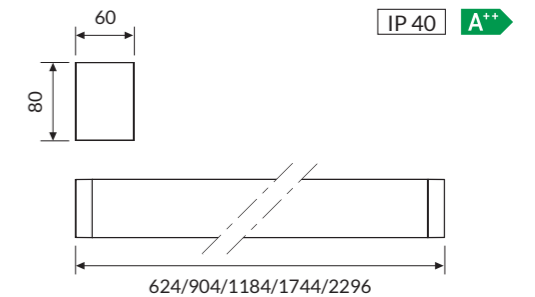
PMMA technopolymer with surface treatment for completely uniform light distribution. Integrated LED technology.

**VERSION //**

COD		lm	mm
67PG24L4HCL	24W	1740	624
67PG36L4HCL	36W	2610	904
67PG48L4HCL	48W	3480	1184
67PG72L4HCL	72W	4350	1744
67PG96L4HCL	96W	6960	2296

SPECIFICATIONS

- Colour temperature range from 2700K to 6500K
- DALI DT8 Driver
- Controllable with N/A button or DIMKITHCL management system (see page 582)

