

REM

ID CODE: 13

REM is a range of **emergency fixtures with integrated driver and batteries** that can be specified in either 1-hour or 3-hour configurations. Mounting options include **recessed** installation, surface ceiling and for Esse-ci **three-phase track**. The luminaires are equipped with 3 different types of lens for anti-panic lighting, escape route or with a arrow beam for high ceiling applications.







Design
esse-ci

FEATURES

-  Direct Emission
-  IP 20

LED

-  6500K
- >109 lm/W icon" data-bbox="143 558 158 578"/> >109 lm/W
-  CRI >80
-  Eye safety: RG0/RG1
-  Mac Adams 3
-  L80/B10 >50.000h

CERTIFICATIONS

-  CE
-  A+
-  5 years warranty

ON REQUEST

-  DALI - RDD code (verify the version)
-  S/A version
-  Self-test

Specifications · Built-in driver and accumulator

Optic · Spot
· Escape routes
· Anti-panic

Body Polycarbonate body.

Colour ○ White RAL 9003 - Codice: B
● Black RAL 9005 - Code: C8



REM TRACK

With Eutrack adaptor.
1h/3h autonomy. S/E mode.



IP 40 A*

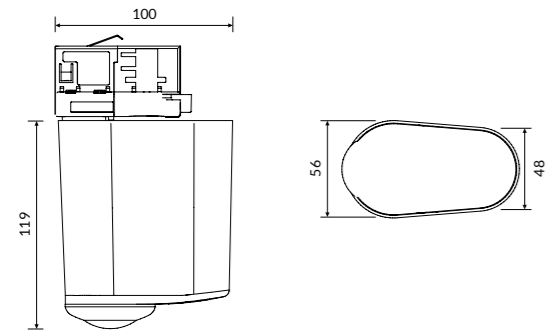

COLOUR TEMPERATURE 6500K

COD		lm
13EM2L65H1	2W	217
13EM2L65H3	2W	217

REM CEILING

For ceiling mounting.
1h/3h autonomy. S/E mode.



IP 40 A*

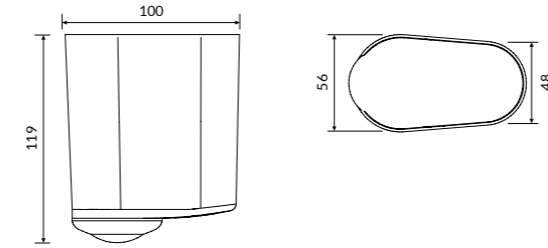

COLOUR TEMPERATURE 6500K

COD		lm
13EM2L65H1C	2W	217
13EM2L65H3C	2W	217

REM RECESSED

For recessed installation.
1h/3h autonomy. S/E mode.



IP 40 A+

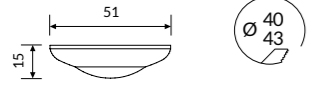

COLOUR TEMPERATURE

6500K

COD	💡	lm
13EM2L65H1R	2W	217
13EM2L65H3R	2W	217

Technical Note

EMISSIONS

