

esse-ci

ID CODE: 51



ceiling



wall



outdoor IP

# MOON

Design: ESSE-CI



MOON is the new device for **wall or ceiling** installations.

The minimal design and **IP65 protection** rating make it suitable for general lighting in any context, both indoor and outdoor, such as stairs, corridors, passageways, parking lots and wherever sober lighting is needed.



ID CODE: 51

# MOON







## SPECIFICATIONS



### FEATURES

-  Direct Emission
-  UGR <22
-  IP 65
-  IK 10
-  -25° -> +40°/45°
-  750°



### LED

-  3000K/4000K
-  >100 lm/W
-  CRI >80
-  Eye safety: RG0/RG1
-  Mac Adams 3
-  L80/B10 >50.000h

### CERTIFICATIONS

-  CE
-  A+
-  5 years warranty

### ON REQUEST

-  DALI - RDD code\*
  -  Emergency kit 1/3 hour  
- EM/EM 3h code\*
- \*verify the version

**Specifications** · SMD LED Technology  
· Built-in driver.

**Optic** Impact resistant polycarbonate diffuser

**Body** Polycarbonate body

**Colour** ○ White RAL 9003 - Code: B  
● Black RAL 9005 - Code: C8

# MOON SMALL

**OPTIC**

Impact resistant polycarbonate diffuser.

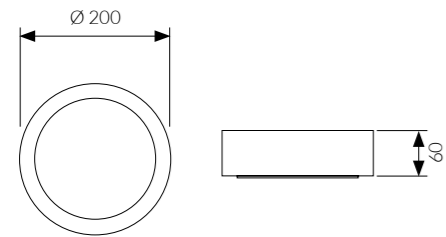

IP 65  
IK10

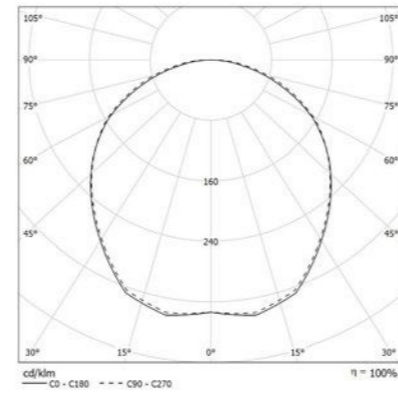

**COLOUR TEMPERATURE** **4000K**

COD		lm
51PO13L4S65	13W	1158

**COLOUR TEMPERATURE** **3000K**

COD		lm
51PO13L3S65	13W	1055

# MOON MEDIUM

**OPTIC**

Impact resistant polycarbonate diffuser.

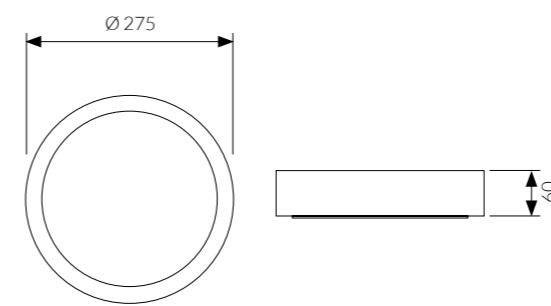

IP 65  
IK10

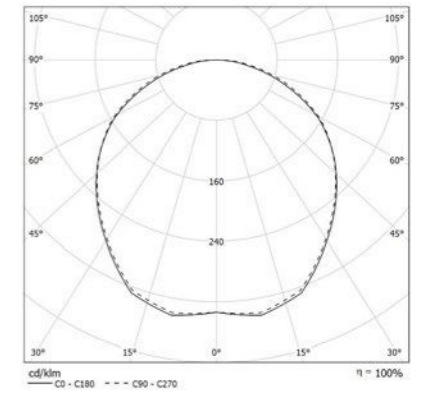

**COLOUR TEMPERATURE** **4000K**

COD		W	lm
51PO18L4M65	18W	2014	
51PO25L4M65	25W	2515	

**COLOUR TEMPERATURE** **3000K**

COD		W	lm
51PO18L3M65	18W	1921	
51PO25L3M65	25W	2340	

# MOON LARGE

## OPTIC

Impact resistant polycarbonate diffuser.

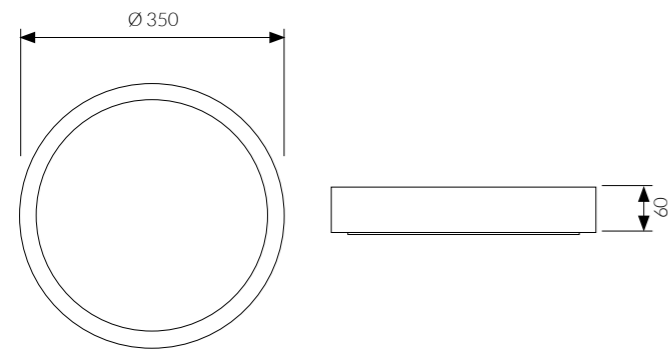

IP 65  
IK10

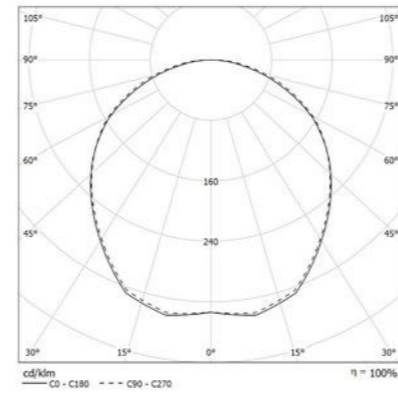

# MOON INTELLIGENT

## OPTIC

Impact resistant polycarbonate diffuser.  
Built-in presence sensor.

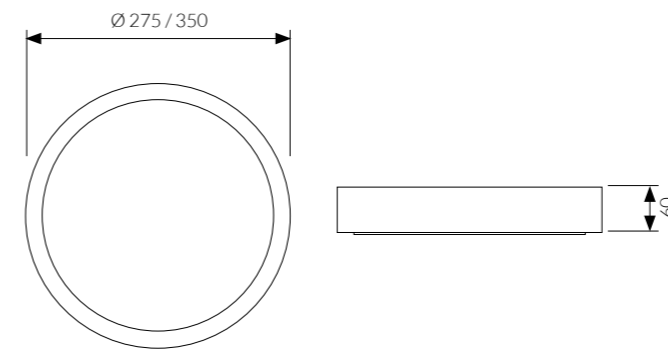

IP 65  
IK10

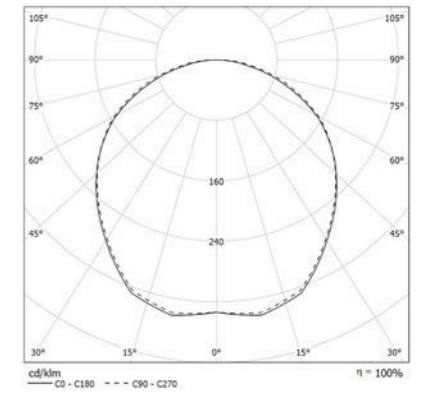

**COLOUR TEMPERATURE** **4000K**

COD		lm
51PO27L4L65	27W	3173

**COLOUR TEMPERATURE** **3000K**

COD		lm
51PO27L3L65	27W	3005

**COLOUR TEMPERATURE** **4000K**

COD		lm	Ø mm
51PO18L4M65I	18W	2014	275
51PO25L4M65I	25W	2515	275
51PO27L4L65I	27W	3173	350

**COLOUR TEMPERATURE** **3000K**

COD		lm	Ø mm
51PO18L3M65I	18W	1921	275
51PO25L3M65I	25W	2340	275
51PO27L3L65I	27W	3005	350