

GROOVE DISPLAY

ID CODE: 43

GROOVE DISPLAY. The technical solutions adopted for ease of installation and precise assembly make the product a pleasant and easy to manage lighting system. The product can be specified in singular form, or in continuous rows, making it ideal for a wide range of applications. The product has been designed for simple recessed installation into plasterboard or slatted ceilings.



See also:

| | |
|---------------------|--------|
| GROOVE | p. 58 |
| GROOVE IP54 | p. 432 |
| GROOVE HCL | p. 480 |
| GROOVE DISPLAY HCL | p. 481 |
| GROOVE DISPLAY IP54 | p. 438 |









Design
esse-ci

FEATURES

-  Direct Emission
-  UGR < 19
-  IP 40





LED

-  3000K/4000K
-  >105 lm/W
-  CRI > 90
-  Eye safety: RG0/RG1
-  Mac Adams 3
-  L80/B10 >50.000h

CERTIFICATIONS

-  CE
-  A++
-  5 years warranty

ON REQUEST

-  DALI - RDD code (verify the version)
-  BT Easy connect - BEM/BES code
-  Emergency kit 1/3 hour EM/EM 3h code
-  2700K - 5000
-  ETL READY

Specifications Built-in driver.

Optic DPL technology diffuser (UGR<19) for environments with display screen equipment.

Body Aluminum extruded body with epoxy powder coating.

Colour Matt white RAL 9003 - Code: B
 Matt black RAL 9005 - Code: C8

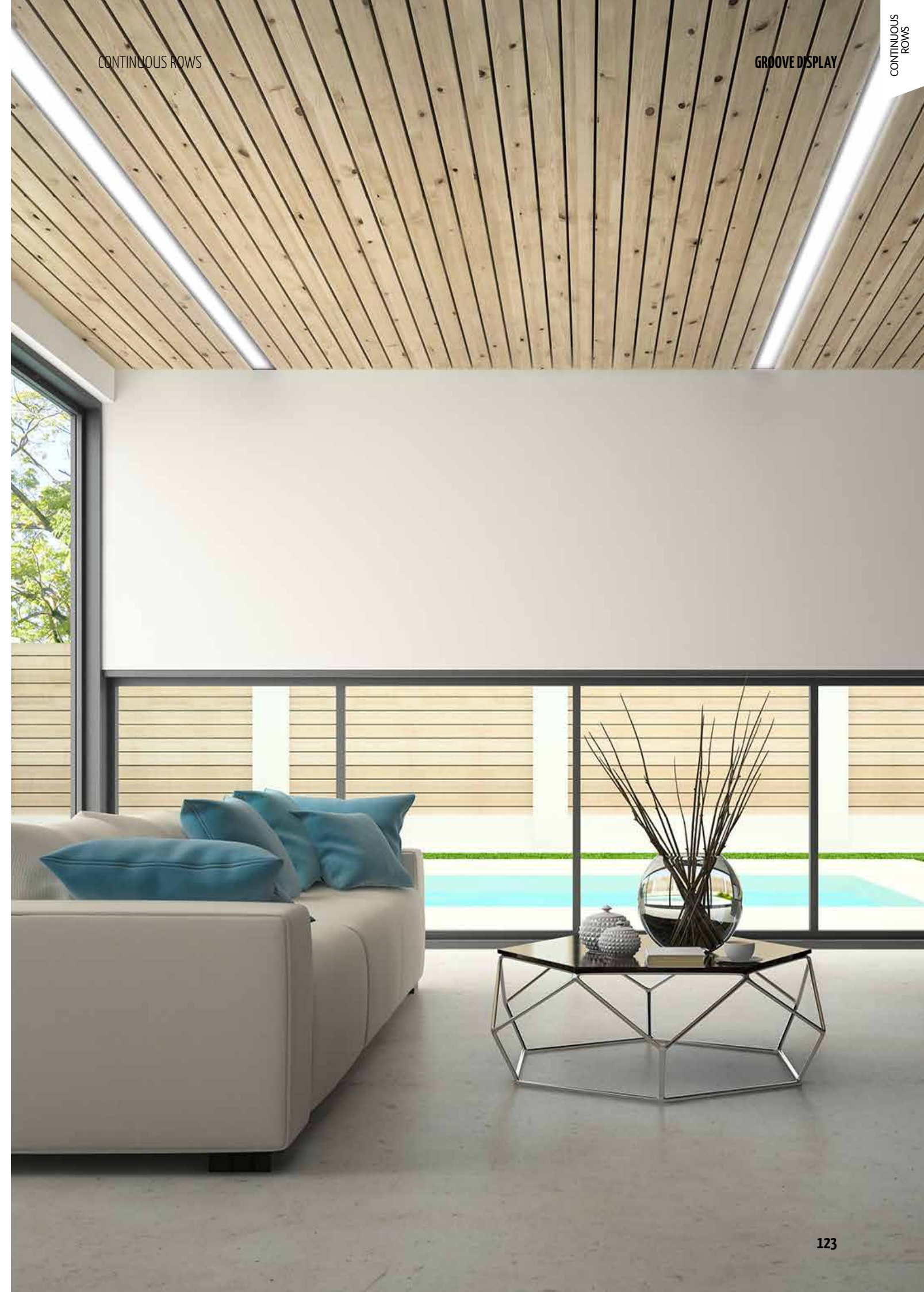

GROOVE DISPLAY LOW POWER

OPTIC

DPL technology diffuser (UGR<19) for environments with display screen equipment.

End caps not included. See accessories on p. 125.

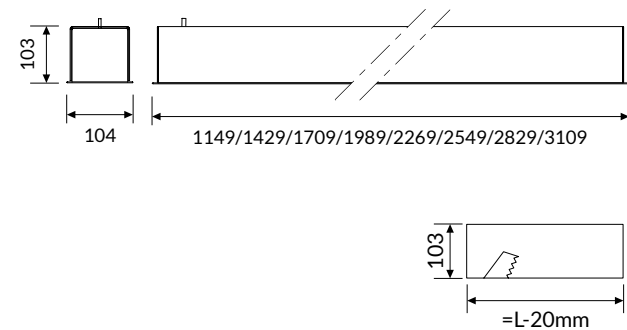

IP 40 A++

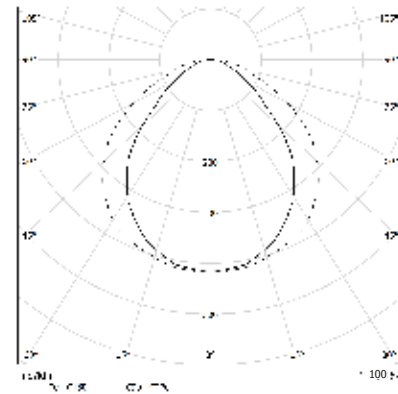

COLOUR TEMPERATURE

4000K

3000K

| COD | 💡 | lm | mm |
|--------------|-----|------|------|
| 43DPL24L490F | 24W | 2520 | 1149 |
| 43DPL30L490F | 30W | 3150 | 1429 |
| 43DPL36L490F | 36W | 3780 | 1709 |
| 43DPL42L490F | 42W | 4410 | 1989 |
| 43DPL48L490F | 48W | 5040 | 2269 |
| 43DPL54L490F | 54W | 5670 | 2549 |
| 43DPL60L490F | 60W | 6300 | 2829 |
| 43DPL66L490F | 66W | 6930 | 3109 |

| COD | 💡 | lm | mm |
|--------------|-----|------|------|
| 43DPL24L390F | 24W | 2343 | 1149 |
| 43DPL30L390F | 30W | 2930 | 1429 |
| 43DPL36L390F | 36W | 3515 | 1709 |
| 43DPL42L390F | 42W | 4101 | 1989 |
| 43DPL48L390F | 48W | 4687 | 2269 |
| 43DPL54L390F | 54W | 5273 | 2549 |
| 43DPL60L390F | 60W | 5859 | 2829 |
| 43DPL66L390F | 66W | 6445 | 3109 |

GROOVE DISPLAY HIGH POWER

OPTIC

DPL technology diffuser (UGR<19) for environments with display screen equipment.

End caps not included. See accessories on p. 125.

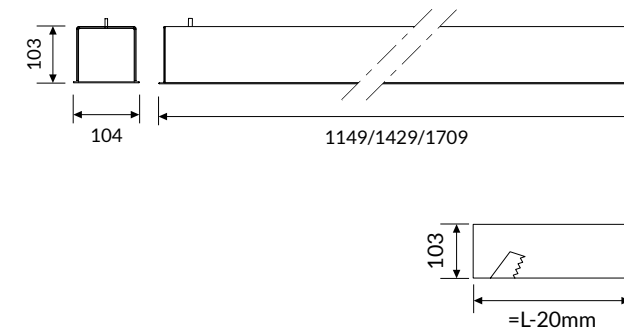

IP 40 A++

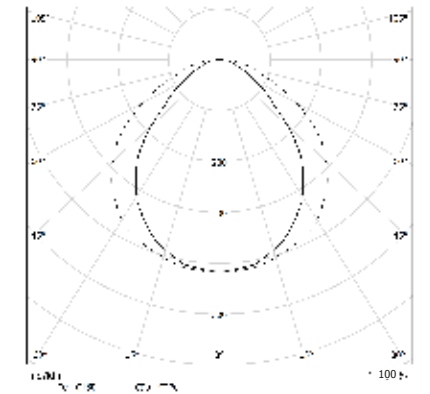

COLOUR TEMPERATURE

4000K

3000K

| COD | 💡 | lm | mm |
|----------------|-----|------|------|
| 43DPL45L490HPF | 45W | 4725 | 1149 |
| 43DPL57L490HPF | 57W | 5985 | 1429 |
| 43DPL68L490HPF | 68W | 7140 | 1709 |

| COD | 💡 | lm | mm |
|----------------|-----|------|------|
| 43DPL45L390HPF | 45W | 4394 | 1149 |
| 43DPL57L390HPF | 57W | 5566 | 1429 |
| 43DPL68L390HPF | 68W | 6640 | 1709 |

Accessories



43AA09F
End caps kit.



43AA11F
Linear joint.



43PG10000
Methacrylate satin diffuser UGR<22, 10m coil to be measured and cut on site to provide continuous gap-free light diffusion.